



# **WATER SECURITY**

**STANDARD TEN**



Govt. Resolution No.: Study - 2116 (Q. No. 43/16) SD-4 dated 25.04.2016 in the meeting of the Coordinating Committee dated 29.06.2021 has approved this textbook from the academic year 2021-22.

# **WATER SECURITY**

## **STANDARD TEN**



Maharashtra State Bureau of Textbook Production and Curriculum Research, Pune.



Y7I2C9

The digital textbook and useful audio-visual teaching-learning material of the relevant lesson can be obtained through DIKSHA App on your smartphone by using the Q.R.Code given on the title page of the textbook.

**First Edition: 2021**  
**Reprint: 2022**

© **Maharashtra State Bureau of Textbook Production and Curriculum Research, Pune - 411 004.**

All rights of this book will remain with Maharashtra State Textbook Production and Curriculum Research Board. No part of this book may be quoted without the written permission of the Director, Maharashtra State Textbook Production and Curriculum Research Board.

**Subject Committee :**

**Shri. Chandrakant Dalvi, Chairman**

Shri. Popatrao Pawar

Shri. Suresh Khanapurkar

Dr. Datta Deshkar

Shri. Upendra Dhonde

Dr. Umesh Mundalye

Dr. D. M. More

Shri. Rupesh Dinkar Thakur

Shri. Shitalkumar Sopanrao Bhong

Dr. Manjusha More

Dr. Prachi Rahul Chaudhary

Dr. Irfan Aziz Inamdar

Dr. Nanda Santosh Haram

Shri. Vikas Gunawantrao Jadhav

Shri. Rajiv Arun Patole, Member- Secretary

**Cover and illustrations:**

**Shri. Vivekananda Shivshankar Patil**

**Typesetting:**

DTP section, Textbook Bureau, Pune.

**Translation:**

Shri. Shaikh Irfan Mohmmad

Dr. Manjusha More

**Convener:**

**Shri. Rajiv Arun Patole**

**Dr. Pravin Subhashrao Mohite**

I/c Special officer, Science  
Textbook Bureau, Pune.

**Paper:**

70 G.S.M. Creamwove

**Print order:**

N/PB/2022-23/35,000

**Printer:**

SAHIL PRINT ARTS, THANE

**Subject Study Group:**

Shri. Pramod Baliram Jadhav

Shri. Sudhir Appaya Amangi

Shri. Dayashankar Vishnu Vaidya

Shri. Dilip Vishnu Dhanawade

Shri. Prashant Panditrao Kolase

Shri. Gajanan Nagojirao Mankar

Dr. Sheikh Mohammad Waquiuddin H.

Shri. Siraj Anwar Mohammad Miran

Shri. Sachin Shankar Jadhav

**Production:**

**Shri. Sachchitananda Aphale**

Chief Production Officer

**Shri. Prashant Harne**

Production Officer

**Publisher**

**Shri. Vivek Uttam Gosavi**

Controller

Textbook Production Bureau,  
Prabhadevi, Mumbai-25.

**DISCLAIMER Note :** All attempts have been made to contact copy righters © but we have not heard from them. We will be pleased to acknowledge the copy right holder (s) in our next edition if we learn from them.



## The Constitution of India

### Preamble

WE, THE PEOPLE OF INDIA, having solemnly resolved to constitute India into a SOVEREIGN SOCIALIST SECULAR DEMOCRATIC REPUBLIC and to secure to all its citizens :

JUSTICE, social, economic and political ;

LIBERTY of thought, expression, belief, faith and worship ;

EQUALITY of status and of opportunity ;  
and to promote among them all

FRATERNITY assuring the dignity of the individual and the unity and integrity of the Nation ;

IN OUR CONSTITUENT ASSEMBLY this twenty-sixth day of November, 1949, do HEREBY ADOPT, ENACT AND GIVE TO OURSELVES THIS CONSTITUTION.

## NATIONAL ANTHEM

Jana-gana-mana-adhināyaka jaya hē  
Bhārata-bhāgya-vidhātā,

Panjāba-Sindhu-Gujarāta-Marāthā  
Drāvīda-Utkala-Banga

Vindhya-Himāchala-Yamunā-Gangā  
uchchala-jaladhi-taranga

Tava subha nāmē jāgē, tava subha āsisa māgē,  
gāhē tava jaya-gāthā,

Jana-gana-mangala-dāyaka jaya hē  
Bhārata-bhāgya-vidhātā,

Jaya hē, Jaya hē, Jaya hē,  
Jaya jaya jaya, jaya hē.

## PLEDGE

India is my country. All Indians  
are my brothers and sisters.

I love my country, and I am proud  
of its rich and varied heritage. I shall  
always strive to be worthy of it.

I shall give my parents, teachers  
and all elders respect, and treat  
everyone with courtesy.

To my country and my people,  
I pledge my devotion. In their  
well-being and prosperity alone lies  
my happiness.

## Preface

Dear students,

Welcome to Class X. You are studying various subjects as per National Curriculum Framework 2005, State Curriculum Framework 2010, State Secondary Education Curriculum 2012 and Restructured Secondary Education Curriculum 2016. As per Govt. misc. 2019 / S.No. (243/19) SD4, dated 8th August 2019, Water security is a compulsory grade subject for secondary education level from the academic year 2020-21. We are very happy to handover you the tenth grade textbook on water security. Studying various subjects from primary level till now has developed various abilities in your personality.

You all know that there are different kinds of problems in the environment. They are based on various factors. At the school level, the main objective of the curriculum is that, students should study the environment issues, and suggest solutions and behave accordingly. The issue of water security has been framed with the same objective in mind. While studying the subject of water security, you have to carefully observe the situation, the relevant factors around you. Understand the various concepts, principles, theories in this subject and relate them to daily practice. The major components of water education, water conservation, water management and water quality are covered in this textbook. The textbook has been deliberately based on information and activities while designing the topic of water security. You must apply the complete information of the subject through activities and projects.

The main purpose of this textbook is to understand and apply the knowledge of water security related to our daily life and explain its application to others. In the textbook, various concepts, theories are explained through figures and activities. Exercises are also given along with it. Try all these activities, experiments yourself to understand the subject properly. Take the help of your teachers, parents, society and classmates as you practice. Connect the knowledge you have learned with your daily life.

In today's fast paced world of technology, you are familiar with computers and smartphones. Therefore, make proper use of information communication technology tools while studying this water security textbook. Be careful while handling various apparatus, important materials while doing activities and experiments and tell others to be careful too. Also try environmental conservation while doing activities, observations. Take care that plants and animals are not harmed. While reading, studying and understanding this textbook, please let us know your favorite part of it as well as the difficulties encountered while studying.

Best wishes to you for your academic progress.



(Dinkar Patil)

**Director**

Maharashtra State Bureau of Textbook  
Production and Curriculum Research,  
Pune 4

Pune

Date : 04/06/2021

# The Constitution of India

## Chapter IV A

### Fundamental Duties

#### ARTICLE 51A

**Fundamental Duties- It shall be the duty of every citizen of India–**

- (a) to abide by the Constitution and respect its ideals and institutions, the National Flag and the National Anthem;
- (b) to cherish and follow the noble ideals which inspired our national struggle for freedom;
- (c) to uphold and protect the sovereignty, unity and integrity of India;
- (d) to defend the country and render national service when called upon to do so;
- (e) to promote harmony and the spirit of common brotherhood amongst all the people of India transcending religious, linguistic and regional or sectional diversities, to renounce practices derogatory to the dignity of women;
- (f) to value and preserve the rich heritage of our composite culture;
- (g) to protect and improve the natural environment including forests, lakes, rivers and wild life and to have compassion for living creatures;
- (h) to develop the scientific temper, humanism and the spirit of inquiry and reform;
- (i) to safeguard public property and to abjure violence;
- (j) to strive towards excellence in all spheres of individual and collective activity so that the nation constantly rises to higher levels of endeavour and achievement;
- (k) who is a parent or guardian to provide opportunities for education to his child or as the case may be, ward between the age of 6 and 14 years.

### Standard 10<sup>th</sup> Water Security : Competency Statements

Unit	Competency Statements
Water Education	<ol style="list-style-type: none"><li>1. To explain the relationship between the environment and the ecosystem.</li><li>2. To be able to tell the types of environment.</li><li>3. To tell the types of ecosystems.</li><li>4. To tell the impact of human intervention on ecosystems.</li><li>5. To explain the relationship between environment and ecosystem with water.</li><li>6. To save the ecosystem as well as to make proper use of water for the ecosystem.</li><li>7. To tell the importance of water culture by explaining it.</li><li>8. Being able to tell others the historical records and information about water management with others.</li><li>9. To be able to take measures for the preservation of waterculture.</li><li>10. To know the measures taken in the past in the field of water management and try to maintain it.</li><li>11. To explain the structure of rain gauge.</li><li>12. Making a rain gauge and recording the rainfall based on it.</li><li>13. Knowledge of various instruments for evaporation, surface flow measurement, seepage measurement etc.</li><li>14. To explain various concepts related to water measurement.</li><li>15. To explain the methods of measuring groundwater reserves.</li></ol>

<p style="text-align: center;"><b>Water Conservation</b></p>	<ol style="list-style-type: none"> <li>1. To be able to explain the concept of water plan.</li> <li>2. Explain the stages of preparation of water plan and be able to prepare water plan directly.</li> <li>3. To be able to present the need of water and availability of water by explaining what is water balance ?</li> <li>4. To explain the importance of maps (Toposheet) for water plan.</li> <li>5. To be able to explain the importance of water plan of public meetings and <i>gram sabhas</i>.</li> <li>6. To be able to participate in village <i>shivar feri</i> and to be able to collect information of water plan explain various processes in that regard.</li> <li>7. To explain the importance of public participation in water conservation.</li> <li>8. To be able to make inferences and conclusions based on the various works completed through public participation.</li> <li>9. To be able to present the process / steps for water conservation through public participation.</li> <li>10. Being able to take interview of various water experts by studying public participation examples.</li> <li>11. To explain the objectives of public participation.</li> <li>12. To prepare a work plan to complete a water conservation work in the area.</li> <li>13. To increase public participation in water conservation.</li> <li>14. To explain the relationship between public participation and water conservation.</li> <li>15. To explain watershed area development programs and various methods of watershed area development.</li> <li>16. To explain how watershed area development can be achieved through agriculture.</li> <li>17. To be able to guide various farmers for watershed area development.</li> <li>18. To suggest solutions to various water problems created in the watershed area/ catchment area.</li> </ol>
<p style="text-align: center;"><b>Water Management</b></p>	<ol style="list-style-type: none"> <li>1. To clarify the rainfall condition of Maharashtra State.</li> <li>2. To explain the correlation between water availability and water consumption in Maharashtra.</li> <li>3. To identify the water challenges Maharashtra facing and suggest remedies on it.</li> <li>4. To explain why water pollution is a major problem.</li> <li>5. To create awareness based on the measures taken on water challenges in the area.</li> <li>6. Being able to explain what irrigation.</li> <li>7. To explain traditional / historical methods of irrigation.</li> <li>8. To inform others about modern methods of irrigation.</li> <li>9. To make awareness through effective and useful methods of irrigation.</li> <li>10. To be able to compare different methods of irrigation.</li> <li>11. To be able to know and explain various laws and regulations related to water management.</li> <li>12. To explain the need for water laws or regulations.</li> <li>13. To be able to study Maharashtra's water policy and form one's own opinion based on it.</li> </ol>
<p style="text-align: center;"><b>Water Quality</b></p>	<ol style="list-style-type: none"> <li>1. Being able to explain what turbidity of water is.</li> <li>2. To be able to make conclusions and estimates by experimenting to measure the turbidity level of water.</li> <li>3. To explain the stages of water purification in detail.</li> <li>4. To be able to study home water purification devices and explain their function and importance.</li> <li>5. To explain various issues by comparing drinking water and river flowing water.</li> <li>6. To explain Earth Over Shoot Day concept.</li> <li>7. To explain the contaminating integration process caused by various events in the day-to-day operations that contaminate water.</li> <li>8. To explain the ideal way of life to prevent water contamination.</li> <li>9. To explain how water is saved by sewage recycling.</li> <li>10. To explain the concept of saline groundwater.</li> <li>11. To explain the concept of recycling saline groundwater as well as use of desalinating seawater.</li> <li>12. To be able to collect various information regarding saline water planning and reuse.</li> </ol>



# Index

Sr. No.	Unit	Chapter	Page No.
1	Water Education	1. Environment and Ecosystem	1-5
		2. Cultural Heritage of Water Wisdom	6-13
		3. Measurement of Water	14-17
2	Water Conservation	1. Water Plan	18-22
		2. Development of Watershed Area	23-29
		3. Water Conservation and Public Participation	30-37
3	Water Management	1. Water Condition and Water Challenges in Maharashtra	38-44
		2. Irrigation	45-49
		3. Water Acts and Rules	50-56
4	Water Quality	1. Water Purification and Sewage (Wastewater) Management	57-62
		2. Environmental Life Style	63-70
		3. Planning of Underground Saline Water	71-74

## For teachers and students

Through the subject of class X water security, the necessary information in daily life has been introduced. Attempts have been made to create awareness and develop a positive attitude towards the various situations around us, some important issues and measures to be taken to avoid adverse effects on their daily lives. It is necessary to strive for the development of personality, inquisitiveness, efficiency and a sense of leadership. While studying and teaching the subject of water security, the steps will have to be taken not only for the purpose of knowing the subject matter but also for the purpose of observation, reasoning through comparison, conclusion and inference. It is important to understand the subject and the activities taken to explain it to others, to experience it for oneself and to make proper application of the information gained. While formulating the subject, the main topics of water security include water education, water conservation, water management and water quality. The arrangement of these chapters has been done not only in the form of information but also with various figures and photographs, activities and experiments. Discuss, Observe, Can you tell? are the titles given to give impetus to the thought process. 'Do you know ?' is the title for additional important information. Through this subject, we want to make our role, actions and behavior useful to the society on many issues such as the water crisis, water scarcity that we find around us and in fact we personally feel. It will help to mould oneself and society.

# Unit 1 : Water Education

## Chapter 1: Environment and Ecosystem

### Let's Recall.

1. What is the meaning of Environment?
2. What is Ecosystem?

### Environment

The environment is a balance of biotic, abiotic, geographical and social factors that affect each other. There are limitations to the use of each of these factors or components. If all these factors are used in balanced manner, natural resources will not be abolished. The interaction between biotic and abiotic elements in the environment and the principles related to their interaction are studied under environmental studies.

Food, clothing, and shelter are basic human needs and are dependent on the environment. Also the plant and animal bodies contain various abiotic elements; e.g. Plants produce food through photosynthesis. Animals depend on plants for their food, while some animals depend on other animals for their food. The original energy is derived from the Sun. The same energy is transmitted from one element of the environment to another. Biotic components decomposes after it dies. The resulting substances from this process are mixed with soil and air.

### Try this.

Some of the components are given below, classify them into Biotic and Abiotic components.

(Plants, Animals, Microorganisms, Sunlight, Air, Water and Land.)

### Types of Environment

**1. Natural Environment:** The various elements that are naturally formed on the earth's surface are part of the environment; e.g. water, air, soil, forest, animals, biological elements, climate, atmosphere etc. It signifies diversity in the natural environment. Such kind of variation is also seen in the structure of natural elements of Maharashtra state. Due to this variation, the *Sahyadri* in the west, the *Deccan Plateau* in the middle, the Coastal region of *Konkan* and the *Vidarbha-Khandesh* are some of the natural structures observed in the Maharashtra.

**2. Man-made environment:** Humans have made radical changes in the natural environment on the strength of their intellect. Such as settlement of human lives, transportation by various means like roads, airways, waterways, railways etc. along with industrial development and establishments of

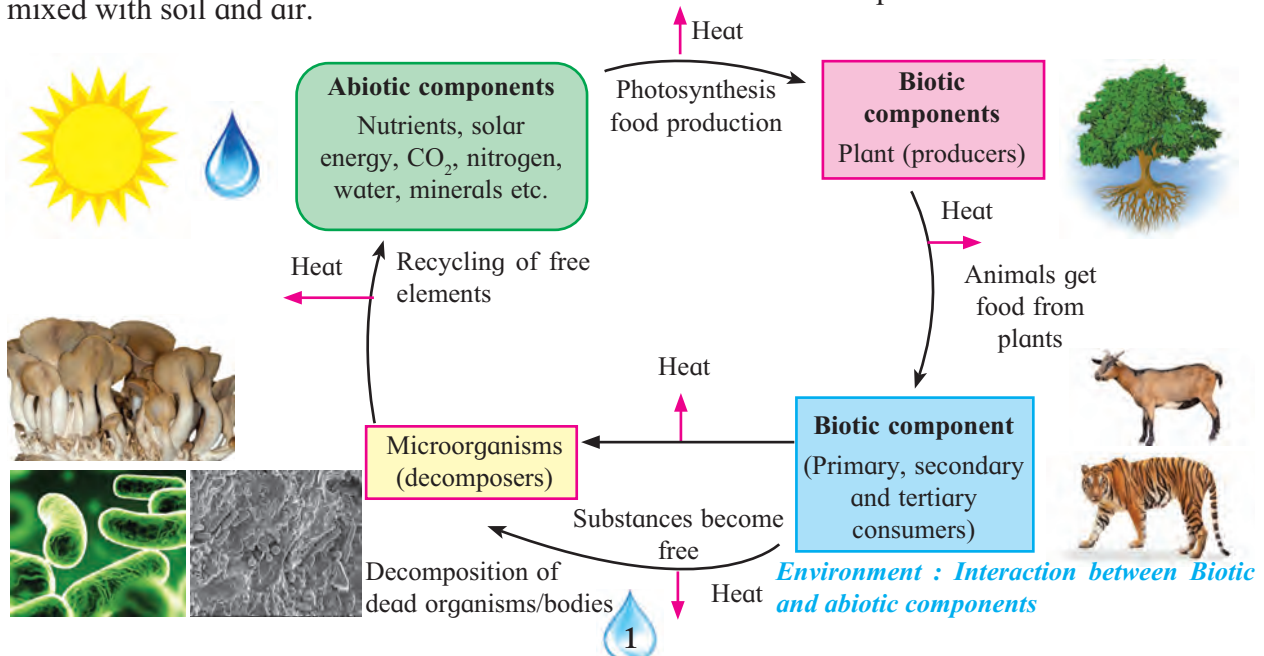

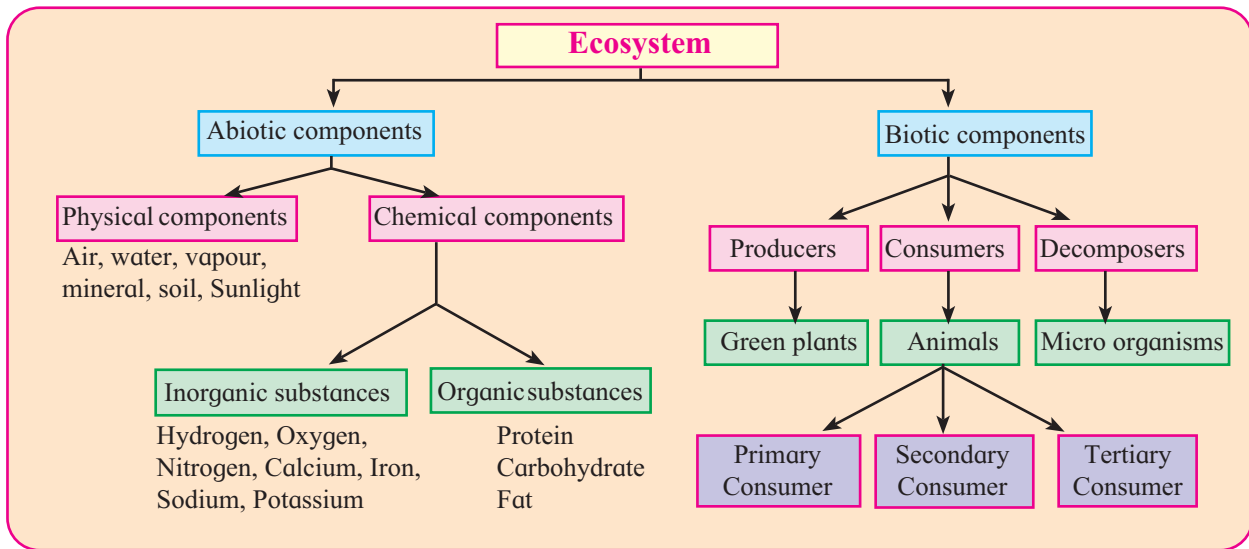

**Ecosystem**

industries are going on rapidly. All these man made elements on this earth is collectively called as 'man-made environment'.

**• What is an ecosystem?**

**Types of Ecosystem**

The relationship between Abiotic and Biotic elements and their interaction is called 'Ecosystem'.

Relationships between the different elements like specific locality, area, size, climate, topography, rock - land, water flow system, etc. are responsible to define the types of ecosystem. Such as land ecosystem, aquatic ecosystem. Even a small watershed or lake can be a ecosystem.

**A. Land ecosystem:** Grasslands, Forests, Deserts.

**B. Aquatic ecosystem:** River ecosystem, Marine ecosystem, Lake ecosystem.

**A. Land ecosystem:** Currently the forest ecosystem covers about 9.4% of the total surface area of the earth, i.e. about 30% of the total land.

**Collect information.**

1. Districts in Maharashtra with forest cover

Sr. No.	Nature of Forest	Names of Districts
1.	Districts with highest forest cover	.....
2.	Districts with moderate forest cover	.....
3.	Districts with lowest forest cover	.....

2. How much forest area are there in your district?



*Land ecosystem: Grasslands*



*Land ecosystem - Deserts*

Forests provide natural shelter for living beings. Forests regulate the water cycle and protect the land surface. Forests meet human needs; e.g. wood, medicinal plants, honey, etc. Evergreen forests, semi-evergreen forests, deciduous forests, rain forests, tropical forests are included in this type of ecosystem.

- **Types of forests in Maharashtra**

The forest types mainly found in Maharashtra are as follows.

**1. Evergreen Forests** - Evergreen forests are found in the areas with abundant rainfall (360 - 600 cm). Trees found in these types of forest are evergreen throughout all the seasons.

Such forests are seen on the Ghats at Mahabaleshwar, Matheran, Bhimashankar, Khandala and western slopes of the *Sahyadri*. *Hirda, Jambhul, Mango, Bel, Khair, Ritha, Anjan* etc. trees appear mainly in these forests.

**2. Semi-Evergreen forests** - The lower regions of evergreen forests where rainfall is slightly lower (200 to 360 cm) and temperature is slightly higher. Partially evergreen forests are seen in this region are called as Semi-Evergreen forests.

Few parts of the western slope of the *Sahyadri* is covered by this type of forest. *Ain, Keenjal, Behda*, etc. trees are found in this type of forest.

**3. Wet deciduous forests** - Wet deciduous forests are found on mountain slopes and in some places even on the surface with very little rainfall (150 to 200 cm.) and higher temperature.

Useful trees like Teak (*Sag*), Shisam, *Savar, Kalamb, Shirish* etc. are found in these forests.

**4. Dry deciduous forests** - Dry deciduous forests are the forests where leafless dry stems of all the trees / shrubs are seen in the region with rare rainfall and highest temperatures.

*Tivas, Amla, Shendari, Palas, Dhaman, Temburni* etc. trees are found in these forests.

**5. “Khajan” forests along the bay** - The forests observed in the wetland and muddy regions along the bay of Konkan region are known as “*Khajan*” forests. Also known as the Mangrove Forest. The trees in these forests are *Tiwar, Ambeti, Kajla, Samudraphal* etc.

**Internet my friend**

Search the map through internet that showing the forest resources of Maharashtra and collect information about various forest regions of Maharashtra and related forest types and present it to the class.

**B. Aquatic ecosystem:** There are two main types of aquatic ecosystems; one is freshwater ecosystems and the other is saltwater ecosystems. Freshwater ecosystem is also classified into stagnant water ecosystem and flowing water ecosystem.

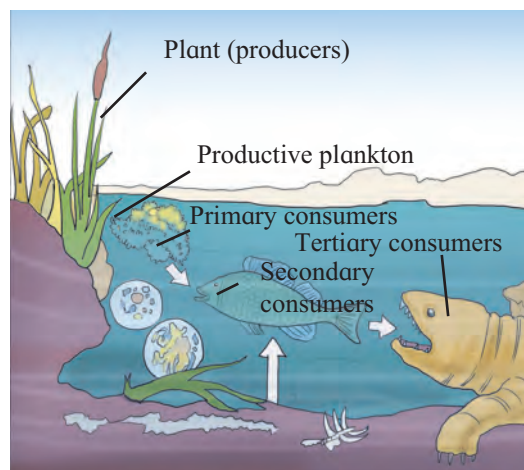

*Aquatic ecosystem: Interaction*

Various components of the ecosystem interacts by water, carries nutrients and is further used by organisms in the ecosystem. Biodiversity in these aquatic ecosystems depends on the natural characteristics of the water depth, cleanliness, alkalinity, temperature, light, amount of oxygen and carbon dioxide gases, flow speed, various substances in the water, etc. This ecosystem is habitat to an aquatic life. This ecosystem includes marine environment as well as water systems such as lakes, rivers, ponds and wetlands. These ecosystems provide abundant natural resources to human being.

## • Water for the environment

To keep the work of the ecosystem uninterrupted rivers, ponds, bays, wetlands, etc. water resources play an important role. Local wildlife, agriculture, irrigation, fishing, timber production, bee keeping, etc. depend on these water sources. The water sources and their associated terrain provide food, clothing, and shelter to the mankind living there. Therefore, it is necessary to save separate amount of water for the ecosystem as an alternative to the environment.

In order to keep the water dependent elements of the environment and the processes in the ecosystem uninterrupted, small amount of water is deliberately kept separate from the available water sources, it is called as 'water for the environment'.

### Correlation between ecosystem and water

For the development of aquatic ecosystems and land ecosystems water is essential factor. In land ecosystem, grass lands and deserts are included. The forest ecosystem covers about 30% of the land. There are two types of aquatic ecosystems.

1. Fresh water ecosystems
2. Saline water ecosystems.

These ecosystems fulfilled the physical needs of human beings. But water is essential for the overall development of this ecosystem. Without water, nutrients cannot be transported. Since biodiversity is dependent on water, water and ecosystems are interdependent and closely linked.

## Balanced use and conservation of water in ecosystem

All water sources must have water to keep the ecosystem functioning. Once upon a time rivers and streams were flowing throughout the year. Today, however, rivers and streams dry up immediately after the monsoon and the ecosystem is endangered due to heavy pumping of water. Therefore, to keep the ecosystem alive, everyone should use water sparingly by pumping minimum amount of water. In short, there is a need to keep a lot of water flowing in the water resources through water protection and water conservation.

### Water plays an important role for the environment as follows

Water for the environment is in the rivers, streams and also in restoring natural flows linked to wetlands.

All living beings are provided with enough water at their essential stages so they don't have shortage of food. Hence they continue their reproduction and growth cycle.

This water plays a major role in maintaining the health of rivers and wetland regions. So it supports the ecosystems depend on them.

### Use your brain power.

1. What is the relationship between biotic and abiotic elements in the environment?
2. What are the components of an ecosystem ? Write the information and make a table.

### Observe and discuss.

Observe the photographs given below and discuss about environment or ecosystem.



### Try this.

Fill the blanks in the picture using the following words.

(Solar energy, CO<sub>2</sub>, Photosynthesis, Plants, Producer, Consumer, Fodder eating animals, Carnivorous animals, Decomposers)

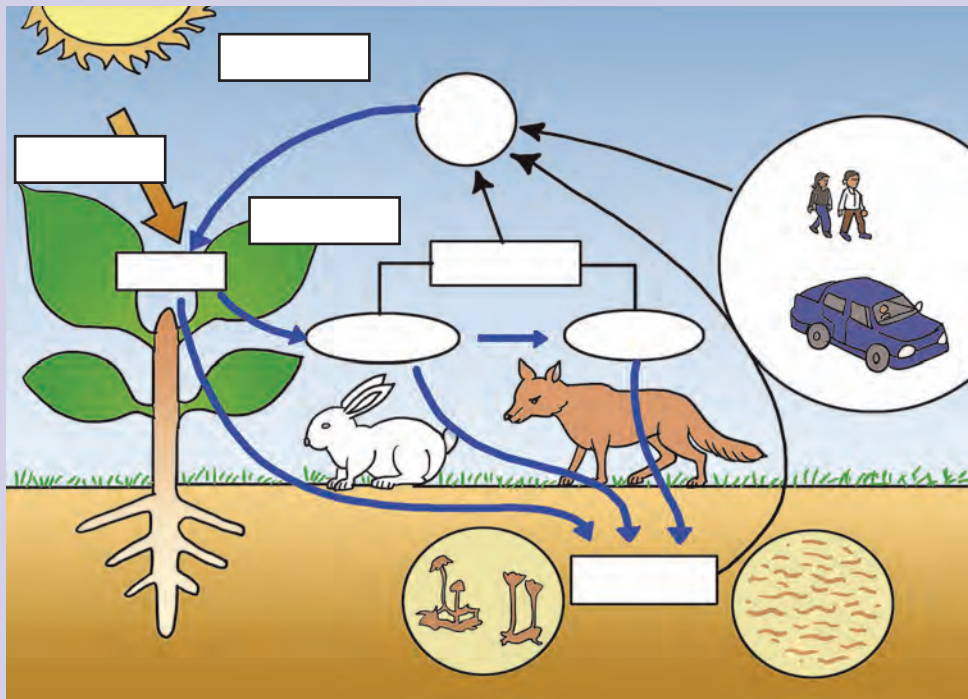

### Internet my friend

1. Find out the types of Indian forests and make a table.
2. Names the National Parks and Sanctuaries along with their states.
3. Give the information on incidents caused by human intervention.

### Exercise

1. What are the effects of human intervention on the environment?
2. What are the main types of ecosystems? Explain the basis of this classification.
3. What important role does water play for environment?
4. Does uncontrolled use of water from natural water sources affect the ecosystem as well as environmental processes?
5. What are the adverse effects of widespread human intervention in the environment on natural water resources?
6. What is the ratio of forest cover to total land area in Maharashtra?
7. Which is the most forested and least forested region in Maharashtra?
8. What are the types of forests found in Maharashtra? What is the percentage of proportion of each type of forest with respect to the area?

# Unit 1 : Water Education

## Chapter 2 : Cultural Heritage of Water Wisdom

### • Human evolution and Understanding of *Panchatatva*

The brain has played an important role in human progress. As the human brain is more advanced than other animals, the changes in nature are observed by it. Humans have come to realize from their observations as per their ability that the origin, operation, and destruction of living things depend on soil, water, sunlight, air, and space, the five major elements found in nature. We call it as '*Panchatatva*'. Earth, water, fire, air and sky are *Panchatatva*.

Assuming that all living or non-living things are made up of *Panchatatva*, the ideal way of life emerged by faithfully following the laws of nature while respecting these five tatvas (*Panchatatva*). In this way a close relationship developed between Indian culture and spirituality.



*Panchatatva*

As water is one of from *Panchatatva*, just like human life water has a unique significance in Indian culture. There was plenty of water in ancient times. In the *Rigveda*, the *Yajurveda* and the *Atharvaveda* has mention construction of dams to block river water, construction of canals to supply water to remote areas, it is also recorded that wells have been constructed for ground water use. But increasing human intervention has adversely affected the available water resources and today there is a crisis of water scarcity.

### Ancient culture on the bank of the river *Saraswati*

Many descriptions of the ancient culture that flourished on the banks of the river *Saraswati* are found in *Rigveda* in various places. There are evidences of the existence of the river *Saraswati* even in the period of Ramayana and Mahabharata. Even today, geological evidence of the existence of the *Saraswati* River is being found, but it is said that this ancient river disappeared due to natural calamities. This means, as a river can create a culture, it can also destroy that culture.



*Ancient culture on the bank of the river Saraswati*

### Varahmihir a Practitioner of ground water

Although the American geologist Menzer is considered to be the pioneer person of modern groundwater science, about one and a half thousand years ago in India, *Varahmihira* wrote four chapters on the subject of 'water' in his grantha '*Brihatsamhita*'.

It gives the information about soil texture, botanical studies, ant hills near trees and deals with the relationship of groundwater to the behaviour of animals such as frog, fish, snake, lizard, monitor lizard, mongoose, cobra, turtle etc. Since *Varahmihir* lives in the area of black stone, his study have special importance in the region of black stone (Besalt) in Maharashtra, Madhya Pradesh.

## Great Agronomist Parashar Muni

Indian culture has always been agricultural. Therefore, *Parashar Muni* had recorded useful observations in his grantha '*Krishi-Parashar*' in order to forecast the rain water required for agriculture. Also, how to block and store rain water is written in detail in the granth '*Kashyam Krishisuktam*'. In his observations, he had mentioned the direction of winds in different months, water level in the river basin, changes in the behaviour of ants, frogs, peacock, snakes, and the relation of the position of the Sun and planets, constellations to rain etc.

## Water advanced society

With reference to water culture *Dnyaneshwar* has given important descriptions about rainfall, *Parjanya*, environment, public water conservation, irrigation, drought, floods etc. When *Maurya*, *Satvahana*,

*Chalukya* and *Rashtrakuta* had govern in Maharashtra that was a golden period of water management. We see many examples of water storage and water management through water advanced societies.

## Archaic structure

*Devtakya*, tank, ponds can be seen near all the caves and forts in Maharashtra. This is mentioned in the inscription at *Ajanta Caves*. The *Rashtrakutas* had constructed *Jagtung Sarovar* near *Kandhar* in Nanded district, *Satvahanas* had constructed *Hersul Lake* near *Aurangabad* and *Kushyagupta Vaishya* had constructed *Sudarshan Sarovar* at *Girnar* on the instructions of Emperor *Chandragupta Maurya*, all they proved their awareness about water. During the *Chalukya* and *Yadav* periods, a large number of *Barwa* (a square well with steps) and lakes were created.



Mariyaman teppakulam lake



Trench around the fort at Nanded in  
Kandhar district



Temple area – Pushkarani



Water Devtake at Sinhgad, District Pune

Water management in ancient period



## Ancient lake culture

A 'lake' is a natural or artificial reservoir in a low lying area of land that is given an architecturally fixed shape by the construction of edges, ridges, sculptures, etc. Lakes are smaller in size than sarovar and larger than wells. The lake is also known as *Pushkarani*, *Vapi*, *Vapika*. Some of these names are specific. For eg. *Pushkarani* means lotus pond, depending on its size *Surya* (Sun) *Pushkarani* and *Chandra* (Moon) *Pushkarani* such subtypes are found.



*Pushkarani*

Like rivers, lakes have religious significance in India. Lakes and especially Pushkaranis are found in most of the temple premises. The number of lakes are higher in areas where large rivers are less in number. It was a practice to build *ghats*, lamp tower, pillars, big gates, etc. near this lake. In those days it was not the king's job to supply water, but people were fulfill their water needs through their own efforts. At that time, building a lake for public use was considered virtuous according to *Dharmashastra*. Such lakes were built and offered for public works. Even today, we can see the record of this in the place of such lakes.

There are six types of lakes in the grantha '*Aparajit Prachcha*' (12<sup>th</sup>-13<sup>th</sup> Century) by Bhuvandev. They are 1. Crescent shape '*Sar*' 2. Round shape '*Mahasar*' 3. Square shape '*Bhadrak*' 4. '*Subhadra*' is made by connecting *Bhadrak* to each other 5. '*Parigh*' in which herons come down in the lake 6. Two '*Parigh*' connected to each other is '*Yugmaparigh*'.

Apart from this, the types of lakes are described as large lake which have of length of one thousand '*dand*', half of it is medium and one fourth is small. These types are according to the dimensions. The dimensions are described as 50 hands large, 25 hands medium and 12 hands small.

The lake has been used in the village since ancient times for many reasons such as water supply, adornment of temples, religious activities, fire extinguisher, for beautification, facilities for travellers. If the lakes are of natural spring or artificially stored water, the sweetness of water varies accordingly. In order to make the ponds last longer by constructing dams or water stored by digging the ground, it is noticed that sludge is being transported in the past. The process of water absorption from the pond can be prolonged by stone construction of the pond.

In historical times, it was customary to build cold storages, '*baradari*', gardens, decorative balconies and arches along the embankment of lake. *Rajsamand* of *Udaipur* (1662-76) and *Anasagar* of *Ajmer* (12<sup>th</sup> century) are good examples of this.

In Varanasi, it is said that the three rivers *Varuna*, *Assi* and *Ganga* were connected by a network of lakes in the past. Lakes are planned in the town structure at *Mandwagad* near Indore. The *Jahajmahal* (Mandu) area is also famous for its lakes. 'The Golden Lotus Lake' at the *Meenakshi* Temple in Madurai is famous. It is said that mythical legend *Indra* bathed in this lake to get free of the sin of *Brahmahatya*. The lake is surrounded by a large hall and fortier. This is the place where '*Bandiyur*' or '*Mariyaman teppakulam* Lake' (1645) built by Tirumal Nayak. It is considered to be the large stone lake in South India. It's length is 304.80m and width is 289.56m. As the water is taken from the *Vaigai* river basin, the reservoir does not break. In the center of it there is a small island with a small dome and a temple in the center.

## Modern lake

Lakes also have an important place in modern town planning. Even today gardens, bathrooms, *ghats* etc. are planned near the lake. In the 18<sup>th</sup> and 19<sup>th</sup> centuries many large lakes were built in Mumbai. There were large built lakes in the temples of places like Mahalakshmi, Gavdevi, Laxminarayan etc. Some lakes were blocked up due to the growth of the city and government facilities for drinking and other use of water supply. Recently the lakes at Mumbadevi and Mahalakshmi have been blocked up. The lake has been revived by removing sludge from the *Mankarnika* lake at Kolhapur.

## Ancient water distribution system : Few examples

1. From the copperplate inscriptions it is understood that dams in the *Khandeshi Phad* irrigation system were built by the people of the *Jire Mali* community during the 13<sup>th</sup> to 15<sup>th</sup> centuries.

2. During the rule of King Gaud in Chandrapur, Gadchiroli, Bhandara, Nagpur districts of Vidarbha, the people of *Kohli* tribe used their own money and labour to build about ten thousand cattle ponds.

3. In the year 1572, a '*Khajina Vahir*' was built near Beed. Water was brought to the well from two subways from the adjacent hilly areas. About 212 hectares of agricultural land was irrigated on this well.

4. The pond was constructed using the stone which was found by digging the ground, during the construction of the temple is called '*Pushakarani*'.

5. In front of Daulatabad fort, a large lake was created by blocking water on the hill.

6. The *Bhill* tribe in the *Satpuda* hills started the '*Pat*' method. In the method of '*pat*', the streams and springs flowing in the hilly areas are blocked by stone and soil and turned into dams and from that the water is diverted towards fields.

We can see that Maharashtra's water culture was as rich as India. Maharashtra, which has such a prosperous water tradition, is facing water scarcity today. Today we need to be committed to bring back the water glory of Maharashtra. That is why we should pay serious attention to the issue of water security and take an oath to increase the water resources of the country as well as the states.

## • *Maurya, Satavahana, Wakataka and Rashtrakuta period*

Considering Maharashtra, during the rule of *Mauryas, Satavahanas, Chalukyas* and *Rashtrakutas*, in this period water management was so good that this period has to be called a golden period.

## Do you know?

### Daulatabad Experiment

While facing of water scarcity in Aurangabad district, a unique experiment of water recharge was carried out in the village of Daulatabad. In January, the wells ran dry and due to low groundwater levels, and also water is not available to the borewell prevailed drought-like conditions. The '*Mombatta*' lake, a short distance from the public well, was full of water, but since there was no electricity to pump water, a separate experiment was conducted based on the air pressure learned at the school.

The water from the '*Mombatta*' lake, which is fifteen feet deep in the mountains on all four sides, was released into the nala by pipe using gravity and siphon method. This water was blocked by a wall on a *nala* near a public well at a distance of about 2000 feet. Thus the water supply scheme of the village was realized at low cost. By adopting this experiment, wells that have been lying fallow for years can be cleaned and reused.

In the grantha '*Dhammapada*', written before the *Mauryan* period, mentions various types of irrigation. During this period, emphasis was laid not only on rain water but also on the creation of more and more sustainable irrigation facilities. In *Kautilya Arthashastra*, water pumps for pumping water from rivers, *Bailmot*, *Rahatgadde*, cropping methods as per water availability as well as construction of dams, sludge removal, records of expenditure for control, protection and tax system are also mentioned.

### • Medieval Mughal period

In this period traditions that have been going on for a long time were preserved to some extent. After that, however, good efforts were taken in the *Nizamshahi*. Construction of cattle ponds at Chandrapur, Gadchiroli, Bhandara, Nagpur in Vidarbha, municipal schemes found in the city of Aurangabad in which water is brought from the hills by a curved tube system, in places like Chandwad, Sinnar, Naldurg, construct dams on the river water, diverted and stored that water in the city, such work done. Today in many places such structures are still active.

#### Collect information.

Read the historical books and get the records of water conservation and water management found in them.

### • The period of Maratha rule :

Saint Tukaram describes this period as

दुष्काळे आटले द्रव्य गेले मान,  
स्त्री एकी अन्न अन्न करता मेली,  
लज्जा वाटे जीवा यासाठी या दुःखे,  
व्यवसाय देखे तूटी आली.

People already suffering from war and besides that they also get suffered by drought. *Shivaraya's* fort was safe about water management. *Punyashlok Ahilyabai Holkar* re-strengthened the '*PHAD*' irrigation system. On Pilgrims built *ghats* on the bank of the river, well, also created '*BARAVA*'. The people gained a lot of experience in water management during *Ahilyabai's* tenure.

### • Chhatrapati Shivaji Maharaj

The importance of water on forts is given in the order letter of *RamchandraPant Amatya*. "तसेच गडावरी आधी उदक पाहून किल्ला बांधावा, पाणी नाही आणि ते स्थळ तो आवश्यक बांधणे प्राप्त झाले तरी खडक फोडून तली-किल्ला बांधावा, पर्जन्यकालापर्यंत संपूर्ण गडास पाणी पुरे ऐसी मजबूत टाकी बांधावीत,' गड किल्ले यांची उभारणी करताना आधी उदकपाण्याची सोय करूनच किल्ला बांधावा" Even if there is no water and the place gets the construction it needs, the fort should be built by breaking the rocks. This vision reveals the broad vision of *Shivaraya*.

The importance of water becomes clear from the following statement in the order letter "गडावर झराही आहे, जैसे तैसे पाणी पुरते, म्हणून तितक्यावर निश्चिती न मानावी. उद्योग करावा कि निमित्त्य की जुझामध्ये भाडियाचे आवाजाखाली झरे स्वल्प होताना आणि पाण्याचा खर्च विशेष लागते, तेव्हा संकट पडते याकरिता तैसे जागा जखिरियाचे पाणी म्हणोन दोन-चार तली-टाकी बांधून ठेवून त्यातील पाणी खर्च होऊ न द्यावे. गडाचे पाणी बहुत जतन राखावे."

During the war, due to ammunition live springs, may become dry. As an alternative, every fort should have water storage. The artificially stored water was called '*Zacharias water*'. Care was taken, so that the water does not spoil.



Water management on forts - Gangasagar lake on Raigad



*Khandeshi Phad Irrigation System*

### • **Khandeshi Phad Irrigation System**

This pattern is found on the rivers like Panzara, Girna, Kan, Jamkheli, Buraee and Aarm. *Phad* method is the distribution of shared water according to the availability of water to the share of land owned by different persons / families.

The water of the river is diverted towards the field through channel, canal, *pat* by building a causway of stone. Excess water was released back into the river after it was diverted. The crop in each field is fixed. The dam was probably built by the rulers and later the canal, trenches, dykes beneficiary farmers were preparing themselves. Sludge removal, slope repair was done through labour (*Shramadan*). The guards, *Patkari* were from village. Mostly traditionally, he was given an particular equal share of the farm as income by all shareholders. Corruption, unauthorized

discharge of water were possibly not happening. There was a committee of experienced elders in the village to handle the discipline of use of water. Digging wells in *Phad* area was banned, separate independent irrigation system was banned, if the rules were not followed by individuals or group or village punishment was given.

In this method social reconciliation is justice, there are laws, rules, there is knowledge of water management. Collectively but there is a tradition of preserving freedom. The ideal way of life in the world is to think of the economic progress, education, business, trade of all the young and old in every family. Even today, self-sufficient, autonomous, water management system implemented by village, of village, for village can be re-established.

### • *Malgujari Lake*

These lakes are found in Chandrapur, Gadchiroli, Bhandara, Nagpur districts of Vidarbha, during the rule of King *Gaud*, the *Kohli* tribe built using their own money and labour.

There were lakes on all four sides of the village, connected to each other by canals. In case of heavy rains, channels were made to release excess water in times of crisis. It consisted mainly of earthen embankments covered with stone. In some places, wooden dams as well as wood was used for pitching. Care was taken to ensure that the water level did not rise and that did not enter in the village. There was a beneficiary committee for repair, protection and water distribution. The sludge was dumped in the field. Taxes were paid to the king for water supply. The person to whom the recovery work was handed over was called *Malgujar*.



*Malgujari lake*

About 100 to 300 hectares of land was brought under irrigation under each lake. Work is now underway to clean these lakes and remove the sludge from them.

### • *Khajina well Beed*

The well was built in 1572 at a distance of three kilometers from the city of Beed. Its diameter is 20 meters and constructed by stone. About 212 hectares of agricultural land has been irrigated on this well. The water used to come in well from two subways through the side hills. A stone underpass has been constructed to drain the water so that water does not rise above the level of the subway.

Which carries water across the *Bindusara* river using the inverted syphon system /curvetube system and supplies water to the area beyond.

Necessary arrangements have been made to remove the polluted air both inside and outside. The original distribution unit has eleven doors. It has 11 streams for irrigation.



*Khajina well Beed*

### • *Pushkarani*

There was a tradition, during the construction of the temple, the stone was found while digging the ground the same stone had to be used for constructing a pond. The village had *Pushkarani* for drinking water, for temple-owned farms, for sacred grove, for water use. There was a method of collecting water from the temple premises and roof and diverting it to the lake. Such '*Pushkarani*' lakes are found near temples in Nashik, Aurangabad and *Marathwada*.

Near Ajanta, Ellora, *Pitalkhore* caves, several arrangements were made to collect rain water from the hills, also stone gutters to carry excess water, dams to prevent flood water which built before two and a half thousand years ago. Due to continuous drought in *Marathwada* region, water management skills were also required.

### • *Syphon/Curvetube*

Everyone knows that water flows downhill according to the law of gravity. It is easy to bring water from the mountain to the base, but if that water to go uphill in the opposite direction, the curvetube/syphon method was used. If water is brought down from a high place, it rises to the same height again.

Using this property of water, a large 'Mombatta' lake was created by blocking water on the hill in front of Daulatabad fort and from there the water is brought down by a pipe and raised back to the fort.

#### • **Bhill tribe's pat method**

This pattern can still be seen in large numbers in the Jhabua district of Madhya Pradesh in the Satpuda hills. In this the water flowing from the streams and springs in the hilly areas blocked by stone and soil and diverted towards field through channel. In the middle of the way, if there is any nalla or a valley, then cut a tree trunk in half and make it hollow and make a bridge to carry water across it. Teak (*Saga*) leaves were kept on the edges to prevent leakage of water along the way. Water was supplied for an area of 100 hectares on each *pat*. Water was blocked by creating stone barriers along the way.

#### **Get Information.**

Get information about the relationship between water and culture from the elders, grandparents in your home. Check it and discuss about it in your classroom.

#### • **British period**

During this period water management is under the government system. Numerous reservoirs such as Bhandardara, Khadakwasla, Veer, Ojhar, Darna were created, but their use was mainly for the production of cash crops. Therefore, rural areas had to depend only on wells for irrigation. The British government had neglected to repair the village lake, well, *Baraw*.

We have lack of understanding about that at once our country's culture of ideal water management in rural areas is the development of the country. Even today for development, for urbanization we are creating a new problems. For this, once again, villages have to be considered as the focal point for the reconstruction of Indian aquaculture. Proper methods of water management for ideal village development have to be explained and implemented.



*Bhandardara Dam (Wilson Dam)*

#### **Exercise**

1. Explain the relationship between human evolution and the *Panchatatva*.
2. Write note. a) *Varahmihir* b) *Parasharmuni*
3. Give information about the ancient lake culture.
4. Explain water management in the time of Chhatrapati Shivaji Maharaj.
5. Write briefly *Khandeshi Phad* Irrigation Method.
6. Write information about *Malgujari* lake and *Pushakarani*.
7. Explain the relationship between water and culture.

# Unit 1 : Water Education

## Chapter 3: Measurement of Water

### Can you Recall ?

1. What is water cycle?
2. How is water measured?

Groundwater resources need to be measured properly in order to be preserved properly. Since all groundwater originates from the water cycle, it is necessary to measure all the factors involved in the water cycle such as vapour, rain, flowing water, stagnant water and seeping water.

### • Rainfall measurement

'The device used to measure rainfall is called a rain gauge.'

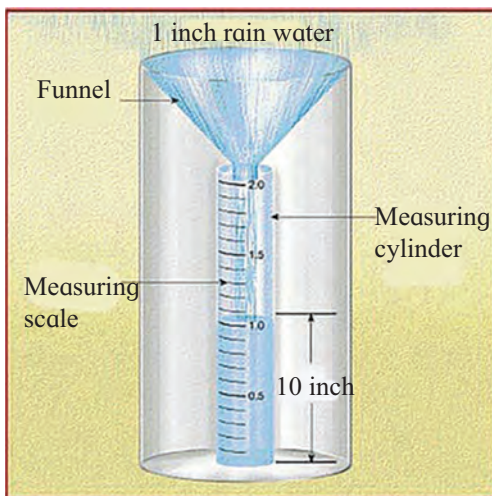

Structure and machine of Rain gauge

### Rain gauge structure

The rain gauge consists of a cylindrical flat bottom measuring cylinder. Some part of this gauge is buried in the ground. Part of this cylinder that stays on the ground has another cylinder inside which can be removed and placed in it. It holds a glass bottle to store water falling from the funnel pipe. The upper side is made up of funnel shape. The diameter of the funnel mouth is 127 mm (5 inches) and the height of an edge is 110 mm (4.5 inches). If there is wind during rain, the edge is sharp and high so that rain water does not flow out of the funnel. The top edge of the gauge is exactly at 30.5 cm (12 inches) above the ground. The rain water that falls on the mouth comes down through a narrow tube and collects in a cylindrical vessel or glass bottle. The diameter of the funnel pipe is made very small so that the rain water does not evaporate.

While measuring water, the height should be recorded by looking at the lower edge of its level. The height can be measured by dipping a water-proof plastic calibrated strip in bottled water. The water in the daily rain gauge is measured once a day at certain time (8.30 am as per Indian Standard Time). In some places such observations are made several times in a day. Similarly, weekly and monthly rain gauges have been made and the cylindrical vessels for storing water are of larger size. In addition, to measure water accurately, weighs the collected water and determine the amount of rainfall. Due to this method, the possibility of not to measure the amount of sewage and water sticking to the pots while pouring water from a pot into the container, is not there.

**Search this.**

1. The highest rainfall place in Maharashtra.
2. The highest average rainfall place in Maharashtra.

**• Evaporation measurement**

More or less dryness, heat, and evaporation in the air determines the amount of evaporation.

The evaporation rate of ground water is higher than that of ground water or any other water. Currently, the state has a large amount of water destroyed by evaporation.

Evaporation is measured by an evaporator. For this, a shallow rounded vessel of iron with diameter size 1.2 m and depth 30 cm, painted white on both sides, placed on a wooden frame with proper aeration from below is used. A measuring tape is placed in the center of the container with an indicator in the center and at 8 'o clock in the morning due to evaporation losses throughout the day are measured by addition of known water quantity.

Evaporation is measured in inches or millimetres. The coefficient is used to calculate the difference between the evaporation in the container and the evaporation from the ground. It is used as 0.65 for Western Maharashtra and *Konkan* and 0.8 for *Marathwada, Vidarbha* region. It is very important that every village has a facility to measure evaporation at least in one place. It is used for water plan.

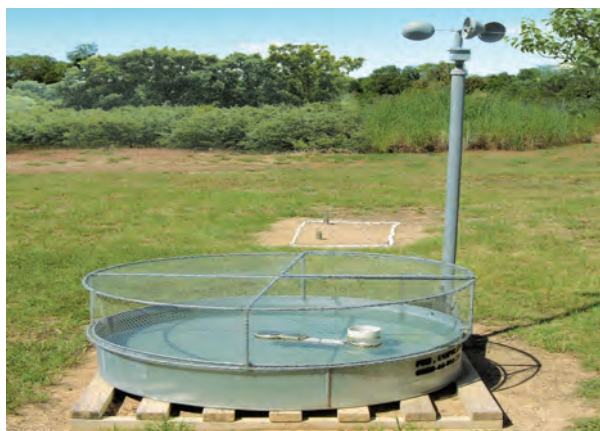

*Evaporation measurement machine*

**Search this.**

1. What is the average evaporation rate of Maharashtra state ?
2. Which district has the lowest evaporation in Maharashtra?
3. Which district has the highest evaporation in Maharashtra?
4. Which district in Maharashtra has higher evaporation than rainfall?

**• Surface flow measurement**

Different instruments are used to measure flowing water such as orifices, meter gates, weirs, flumes and V-Notch.

**V-notch method:**

This tool is a wooden or iron plank with a V-shaped triangular notch in the center (with an angle of  $90^{\circ}$ ). Depending on more or less water flow, big or less small V-shaped notch is used. This wooden plank is placed horizontally in the direction of the water stream (so that the entire stream passes through the groove or notch). The flow of water can be measured in litres per second. The flow can also be measured using a rectangular or trapezoidal notch, but in that case the flow calculation can be more complicated so it is better to use a triangular notch.

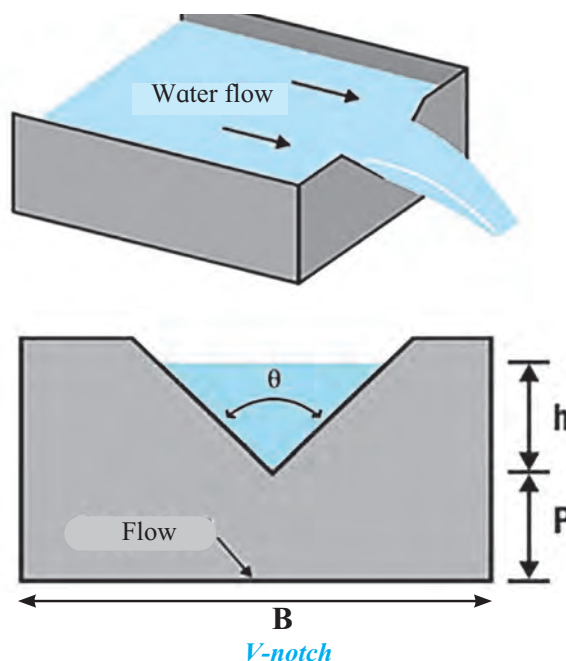



### Measurement of seepage water (“Zirpa”)

The land for which the water absorption capacity or seepage is to be checked, on that land surface round iron ring of 30 cm diameter and 30 cm height is placed which will go 15 cm inside the ground and it will remain straight and a round dam of 30 cm height will be constructed. The ring and the outside space of it are filled with water at once. Then the time is recorded on the clock to note how much of the water level is dropped at every 5 minutes and water is refilled again. Gradually increase the times until the water stays stable for a long time and goes down again. Keep record of the water level for each instance. Then sum of all time values and water level values will be done. It can be used to find how much water goes into the soil per hour.

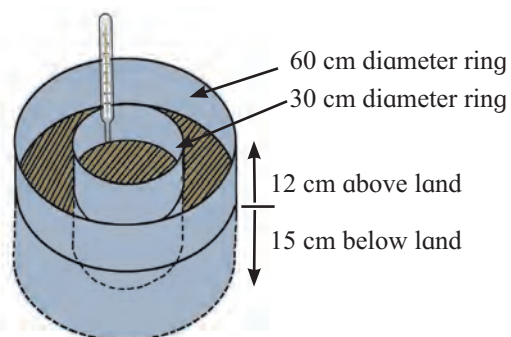

*Zirpa measurement method*

### Surface water reserves measurement

Water reserves are measured by calculating average values for length, width and depth of the reservoir. To measure the water distribution a constant size distributor is used and then speed of water flowing through it is measured. This method of measuring the stored water is called **stationary measurement** method. The measurement of flowing water is called **flow measurement** method.

In the flow measurement method, the flow of water flowing over the dam to a certain measure and the speed of the flow calculated by an equation. The total amount of water is calculated from how long the water can flow.

### Water required for crop

The total amount of water required from cultivation of the crop till the harvest of crop is defined as the total water requirement of the crop. Also, if the measure of water spread over an area of the crop, then the depth of the water level in the soil defines total amount of water required for the crop is commonly used measurement method.

Another method of measuring the water requirement for a crop is by measuring the area per acre of water which will be useful for growing the crop.

Main method	Sub method	Unit
Stationary Measurement	English	(a) Gallon (b) Million cu ft. (c) An acre inch or acre feet is spread of water at 1 inch or 1 feet depth in 1 acre area is used as unit for water measurement.
	Decimal	(a) Litre, (b) Million cu m. (c) Water spread over a hectare area with depth of 1 mm., 1 cm. or 1 m. Then accordingly Hectare mm., Hectare cm., or Hectare m. unit can be used.
Flow Measurement	English	(a) Gallon per minute, (b) Cusec means Cu. ft. per second (c) acre inch per hour or acre feet per day this unit can be used.
	Decimal	(a) Litres per second, (b) Litres per minute, (c) Cu. m. per second (Cusec) and (d) Cu. m per hour these units can be used.

## Do you know the dam water incoming and outgoing water flow measurements units?

### What is TMC?

1 TMC means 1 thousand millions cu. ft. means 1000000000 (1 billion) cubic feet.  
01 TMC = 28,316,846,592 litres

### What is Cumec?

1 cu. m. per second water flow means 1 Cumec. By this unit 1000 litres of water flows out per second.  
01 CUMEC = 1000 litres /second

### What is Cusec?

1 cu. ft. per second water flow means 1 Cusec. By this unit 28.3 litres of water flows out per second.  
01 CUSEC = 28.317 litres / second

## How to draw flood lines?

### White line

When 30,000 cusecs of water is released from the dam, the line where the water level of the river basin reaches is known as the 'white line'.

### Blue line

Once in a 20 to 25 years river water crosses white line. When 60,000 cusec of water is released from the dam, the line where the water level of the river basin reaches is known as the 'blue line'.

### Red line

Once in a 40 to 50 years because of high rainfall river water crosses blue line. When 1, 00,000 Cusec of water is released from the dam, the line where the water level of the river basin reaches is known as the 'Red line'.

### Always remember this.

**Different units for measuring water**

**Different units for measuring stationary water:** Litre , Cubic feet, Cubic meter

**Different units for measuring flowing water:** TMC, Cusec, Cumec

### Try this.

1. Measure rainfall in your area by making rain gauges using waste materials.
2. Record the rainfall of one week in rainy season in your area with a rain gauge prepared by you and show it on a graph paper.

### Do you know?

The capacity of Khadakwasla Dam near Pune city is 1.97 TMC. That means it holds  $1.97 \times 28.317$  billion litres of water. If 500 cusecs of water is released into the river from this dam, then  $500 \times 28.317$  litres per second of water will be released.

### 5 Large capacity dams in Maharashtra

- |                                  |                             |
|----------------------------------|-----------------------------|
| 1. Ujani 117.27 TMC              | 2. Koyna 105.27 TMC         |
| 3. Jayakwadi 76.65 TMC (Paithan) | 4. Pench Totladoh 35.90 TMC |
| 5. Purna Yeldari 28.56 TMC       |                             |

## Exercise

1. Briefly explain the V - notch method of measuring flowing water.
2. Write units for measuring stagnant water and flowing water.
3. Explain the difference between Cusec and Cumec.

# Unit 2 :Water Conservation

## Chapter 1: Water Plan

### Can you recall ?

1. Why planning is necessary to complete a task ?
2. What is planning and management ?
3. What is planning of plan ?

### • What is mean by plan ?

A plan means preparing or designing a task is all about the need for it, the disciplined effort for proper productivity, allocation of work to everyone according to one's ability, enough education to carry out the task properly and then to do honest hard work on it.

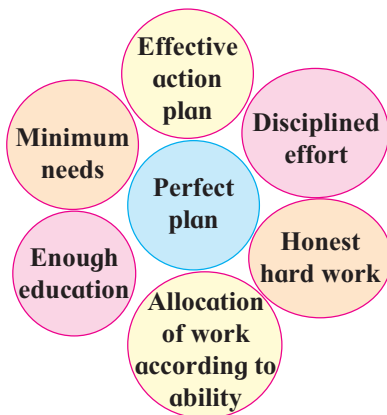

Features of perfect plan

### • What is water plan ?

How much water is blocked in our catchment area in each year? How much of that water seeps into the ground? How much is the evaporation of ground water? Exactly how much groundwater is extracted from the ground? How much water is available for human consumption? The calculation of all this means water plan.

It is important to estimate the water balance properly by taking into account the ideal water conditions, climate, forest area, distribution of animals, birds and resources in the village, so that it understands the damage done to the ecosystem and the picture of difference between our necessary and unnecessary needs becomes clear. There will be a clear idea of future challenges, and from it once the problem is fixed, an ideal plan can be created to restore nature.

### • Water plan set-up

To underline the information of measurement of rainfall in village, determination of observation for keeping ground water level records, fixation of wells obtaining a map of village and drawing of flow of stream (Nale) on it, types of soil-

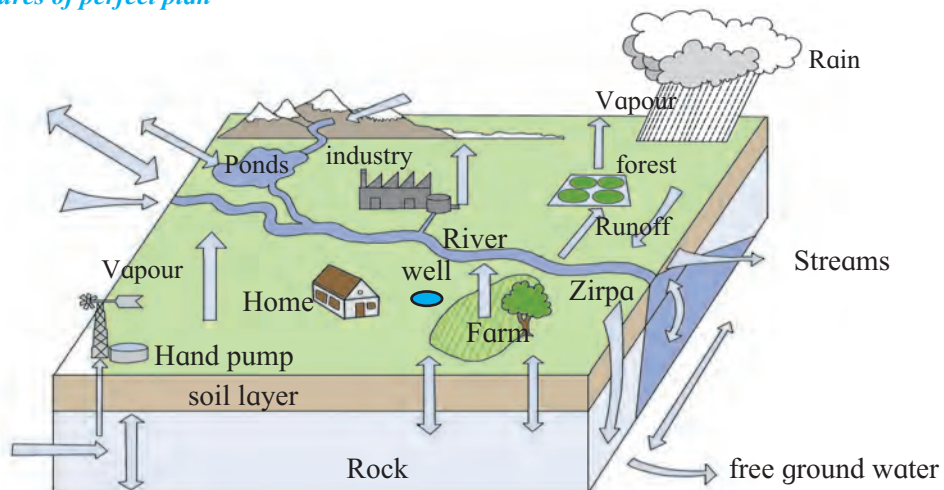

Water Plan

rocks in village, places suitable for recharge, suitable place for obstruction of river-rivulets -water flow, storage of surface water, well, bore well, etc. To be able to present water plan by collecting information of to know the crops taken in the last three years and information of current year's *khari*f crop, crops grown by wells and bore wells and information of number of power pumps used for it and horsepower, details of drinking water sources, details of the scheme and the water available through it, village population and animals.

### • Stages of water plan

The first phase of water management should be started immediately after the normal rainy season stops i.e. after October. In which, the public meeting will be the first step. Procession in village /rounds in village, collection of information, measurement and conclusion should be completed within a month. The available period from January to June –July before the rain should be used for treatment based on the findings of the balance sheet.

#### 1. Public/General meeting

The main objective of the public/general meeting is to get the help of the villagers involved in the watershed area for water planning. The public/general meeting reviews the daily use of water, the use of water for agriculture and industry, the whimsicality of nature and the problems that arise from it. It gives a clear idea of the future drought situation to the members. Even if there is sufficient water availability in the village, there is a need to report the adverse effects of lack of management.

Children, youth, adults, elder, men and women, etc. are represented in the public/general meeting. A water committee is selected with appropriate coordination of education and business as well as enthusiasm and experience. This committee should jointly review the data collection at least four times a year.

The selected water committee is required to prepare the groundwater plan under

the guidance of experts and decide on the implementation framework accordingly. The public/general meeting should be held in two or three sessions of about 1-1 hours. In these 3 sessions, three topics are discussed, namely problem identification, current status and necessary solutions.

#### Collect information and discuss.

What is the format of the public/general meeting? Discuss it in class.

#### 2. Round in the village/ procession in the village

From the one-day workshop, members who have been trained on how to draw a groundwater plan and have experience in village expansion have a procession in village. It is beneficial to have an expert guide available with you. The following information is collected from the village rounds/village procession.

1. Administrative boundary of the village and natural boundary. It is possible to determine how micro and mini watershed areas are there within the village boundary.
2. What type of water source is available and how much water is available from it? This includes flowing water, water blocked as dams, village ponds, farm ponds, water supplied by dams, springs, wells, bore well, number of tanker supply, etc. and water available from there.
3. Water used for domestic use, for industry and for agricultural crops. For this, water used for the cropping system in the village also use in industry and trades, measurement of water required for all human beings and animals.
4. Landforms and geological studies in village areas. Landforms are types of soils according to the texture of the soil, sloping lands, hills- plains, small rivulets, springs, brooklets, river length and width, types of trees in forest area.

## Always Remember

### What?

### For what?

Public/general meeting

Objectives, Procedures / Methods and Schemes for Implementation and Selection of water committee by all Consensus to get mass support .

Procession in village

To collect information by observing landform, geology, crop composition and water resources.

Mapping

Study of Water requirement, water availability

Action program

Effective implementation of water management



*Procession in village*

## 3. Mapping and registration of collected information

This leads to the collection of information at different levels. Problems will be understood from the general meeting, the need and current situation will be understood from the village procession, also get benefited the information collected from various government offices. In addition, some information will have to be made available to the members by taking

## Do you know?

A toposheet of the watershed is required to prepare the water plan. It gives information about small water flows in the watershed, their density, high and low lying areas, roads, communication routes etc. Therefore, it is necessary to use the toposheet of the watershed while preparing the water plan.

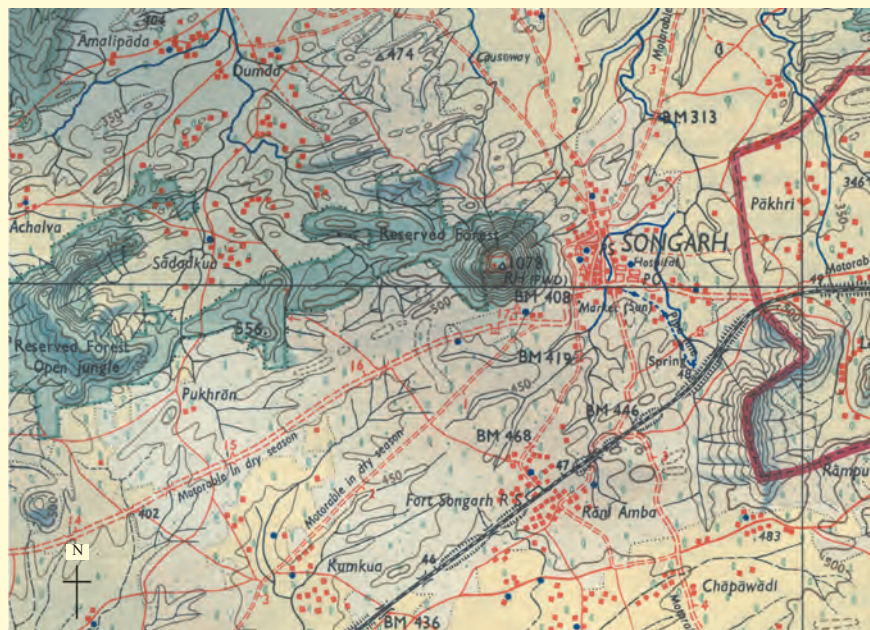
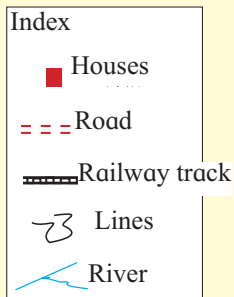
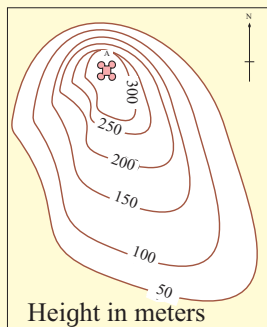

measurements themselves. All this information needs to be recorded in the register as well as on the village map.

The information required for the balance sheet includes landforms, soil-rock type and their depth, rainfall, evaporation, groundwater storage, availability of flowing water, water use equipment. These things also need to be recorded in the register as well as on the village map.

#### • Balance sheet of water

Understood the total water availability, but how many tools are there to use that water? How much water is being used from it? To measure this, the uptake from wells, bore well and ground stocks should be measured. This will determine whether the total water availability is being fully utilized.

The water flowing through the river-rivulets, the evaporation, the water used according to the water-irrigation system, the water used for drinking, water for domestic and industrial use, non perishable water, the water used by the animal-forest area, the condition of water use will be understood from the calculation of the total amount of water used.

#### Try this.

1. Prepare a balance sheet of your household water use.
2. Show all components of the balance sheet by creating a watershed sample.

#### • Formula for calculating groundwater structure using collected information.

**Need of water** = population (Multiply litres per person) + Number of animals (Multiply litres per animal) + Area according to crop composition (Multiply water requirements as per irrigation method) + Business and other use of water.

**Total water availability(100%)** = ( Rainfall  $\times$  area of village) + 10% Runoff coming from the back boundary

**Wasted water** = Vaporization (40%) + Runoff (10 %)

**Distribution of usable water** = Forest area + Rainfed crops + Ground water (40%) and storage (10 %)

#### Search this.

1. Name the rivers in our state for which the water structure have been created?
2. Which organizations prepare small and large watershed water plan ?
3. How is the balance sheet of water in your area?

#### Use your brain power.

1. Which help can we do to prepare water plan?
2. Water plan can be even at the household level, identify its components.
3. Identify the types of water wastes and suggest solutions on it.

#### Discuss.

1. Make a note of the various elements of the water plan you find around you and share it with others.
2. Read a water plan map prepared by any one organisation.
3. Take a copy of water plan of any village prepared by GSDA available on internet. Discuss it in classroom.
4. Share the information to your friends and relatives which you know about the water plan you have visited or studied.

## Exercise

1. What is a water plan?
2. What are the elements of a perfect water plan?
3. What are the steps to be consider while making a water plan?
4. What is a public/general meeting for and who is involved in it?
5. Who should be included in the village procession? Why?
6. What information can you get from the village procession ?Write in detail.

## Unit 2: Water Conservation

### Chapter 2 : Development of Watershed Area

#### Can you recall?

1. What is watershed?
2. What are the types of watersheds?

#### • Development of watershed area

The whole farmland of the village is not flat. Many types of hilly lands are found in the village such as hillslope lands, ditches, flat lands. In short, water of this particular area which naturally flows from the mountains through small streams and flows through a nallah the whole area is called 'Watershed Area'. Such area can range from 50 hectares to 500 hectares or more depending on the elevation of the land.

In order to implement the watershed area development plan, the small watershed area has to be considered as a first priority. The watershed area has to be selected according to the geographical location of the land. Then a water structure of each watershed area should be prepared. In the selected watershed area, various treatments are required to stop the erosion of the ridge to the soil from the top to valley and to stop the flow of water. These include leveling of trenches, nalla (drain) plugs, check dams, nala bunding, cement plugs, seepage ponds, farm ponds, tree and grass planting, dams. Various groundwater conservation works have to be carried out on all the lands in the watershed area to block and redeem water according to the elevation.

#### • Watershed area development program

The following factors are important to consider while developing the watershed area.

1. Rainfall and climate in watershed area.
2. Size, slope and structure of watershed area.
3. Network of rivers-streams, type and its proportion.

4. Type of land out of light, medium, heavy land.
5. The thickness of different soil layers found after digging of land.
6. Geological conditions, types of rocks, decomposition, cracks and joints in it.
7. Availability of spreading of groundwater.
8. The rate of water seeps into the soil.
9. Properties and scope of water retaining rocks.
10. Types of surrounding trees and shrubs, grass and shrubs cover on the ground, types of forests.
11. Information on how and to what extent land is used and methods of land use.

In order to carry out development work of watershed area, it is necessary to first survey the entire area. From this survey we can get information about the ups and downs of the land, the direction of water flow, the type of land, how much water can be blocked from the drain etc. Based on this information, we get to know what kind of work is to be done in the watershed area and to what extent is to be done. The work has to start from the highest point in the area selected for treatment in the watershed. As a result, rainwater from the hills gradually begins to seep into the lower region. As a result, the groundwater level rises in the first year and the water level in the wells below it rises. Thus the area under horticulture increases and so does the agricultural production.

#### • Treatment methods for the development of watershed area

##### 1. Continuous Contour Trenches - CCT

The land at the top of the hill have high slope. The rain water that falls on it is carried away by the force. Therefore, as the soil



becomes more eroded, so this flowing water should be blocked in some places. In order to block the water and to seep it, contour trenches should be dug according to the slope of the land. If the slope of the land is high, dig the trenches almost nearly. However, if the slope is low, the water can be blocked by digging a trench at a long distance. If the land is grassland or barren, then in such barren land/ferine land, at same level Vetiver grass and trees should be planted. Due to this the water flowing down the hill will be blocked by trenches. In addition, due to the causeway of Vetiver grass and the trees planted in place of trenches, the water will seep into the soil as much as possible. Grass causeway can be constructed at low cost and hence water blocking is beneficial.



*Continuous Contour Trenches in hill slope*

The land above the crumbly area is usually light, shallow and muddy (murmud). Land slope is high means 3 to 5 percent. Since the soil is very light, cultivation of crops in such soil is not profitable. Therefore, after digging the contour trenches, trees like Jujube, Jamun, Guava or drought fruit trees should be planted in them.



*Grass planted in two trenches*

The land between the two trenches should be planted with fodder grasses like Pavana, Stylo, Hamata. Grass is useful as a fodder for animals. In addition, grass leaves and sticks fall on the ground and produce good manure by decomposing. It also improves soil texture.

### **Advantages**

1. The soil that flows with the water stays in the trenches and stops the erosion of the soil.
2. Due to the digging of the contour trenches, the rain water falling on the ground seeps into the soil in all parts of the field.
3. Rain water flows for a maximum of 5-6 meters and accumulates in the trenches and seeps into the soil.

### **2. Loose Boulder structure**

Initially, small streams fall on the ground due to rainwater carried on the slopes. In order to block the water flowing through the streams, small causeway of stones should be laid one below the other according to the slope. Small stone causeway should be laid at such a distance that the level of the foundation of the causeway /embankment above the stream and the head of the causeway /embankment below it will be equal. The height of such dams/causeway should be kept upto 2 mtr. depending on the slope of the land. Apply khas grass or other grass on the soil compacted on the embankment/causeway. Also, small shrubs should be planted at a distance of half a meter on the lower side of the dam/causeway. Berry, herbal tea, marigold, basil will strengthen the dam/causeway and water will be well blocked.



*Causeway of small stone*

### 3. Nala embankment/Nala Bunding

Earthen or cement causeways are more useful to block the flow of rain water from the nala. Due to the causeway, water can be stored in the nala. If earthen causeway/dam is to be constructed, the maximum height of the causeway/dam should be 4 meters. The base of the causeway/dam should be dug properly, black soil should be filled in the bottom of the nala so that water does not seep. When constructing such earthen causeways/dams one below the other in the nala, care should be taken to ensure that the flood water of the lower nala does not reach the upper nala. This also increases the water level in the well below the causeway/dam as the water seeps into the soil. In addition, the water stored in the nala can be used for the crops. If the flow of water is high and fast, the earthen causeways/dams on the nalas cannot survive. In such places construction is done in cement and stone instead of soil. In recent times, entire causeways/dams are being constructed using RCC as well as ferrocement.



*Nala Bunding –cement nala bunding*

**The following points need to be taken into consideration while doing the nala bunding work in cement stones.**

1. Watershed area should be 40 hector to 500 hector.
2. The slope of the bottom of the nala should be less than 3%.
3. The width of the bottom of the nala should be less than 30 meters.

### 4. Vanarai check dam

These forest dams are built by filling a mixture of soil and sand in empty cement bags. The slope of the nala should be up to 3%



*Vanarai Dam*

between the two dams. There should be one to one and half meter high nala bank on both the sides of the nala. Considering the slope of the nala and the watershed area, the base should be generally 1.5 to 2 meters wide and 30 meters deep. This base should be equal to the width of the nala. Empty cement bags should be filled with sand-soil mixture and the mouths of the bags should be sewn with plastic thread. This filled bag should be kept side by side to one of the other to form the first layer. When laying the second layer on it, place the second layer sacks on the joints on both sides of the first layer in a joint method. In this way, when 2-3 layers are formed, one layer of soil should be applied on it. This closes the fine cracks in the bags and strengthens the dam. This is simple and easy way to build a 'vanarai' dam at low cost. This can increase the horticulture area by diverting water from the nala.

### 5. Gabion check dam

Rain water in the watershed area flows faster if the slope is higher to the ground. In some places, earthen causeways /dams do not stand up to block the flowing water. Also, concrete cement dams do not provide proper space for sewage and in some places concrete base are not available. In such places, a Gabion dam is more useful for blocking water. Due to these dams water flow slows down and help the water to seep into the soil. In this method the nala bed dammed horizontally by coarse stone mesh in a net. Stones and nets were tied and keep horizontally in the nala and if we put small tree branches, grass, mulch around it, a

good dam is formed. Although the water in the nala is very fast, due to the heavy weight of stones and nets, it is not carried away. Therefore, the blocked water in the nala helps to increase the water level in the lower side of the dam. Besides, the water stored in the nala can also be used for agriculture.

25 cm to 30 cm locust stones should be used for build the dam. It works even if small and big stones are used to it. Such stones are made by putting one to one and a half yarns of size 20 cm by 20 cm in a galvanized mesh (linkmesh) in the Gabion dam nala.



*Net Gabian Dam*

## 6. Loop Bunding

In many places in 'Konkan' or on the hill top water is flowing till the end of December. In such places, water is blocked by constructing concrete dams in the nalas. As the water level rises while storing water in the nalas, this water can be diverted to the fields on the sides of the dam and used for nearby crops. This is done by constructing temporary dams and diverting water to the fields. When selecting a nala, water should normally flow into the nala with sufficient flow (150 liters per second) till the end of December. The bottom of the nala should preferably be of open rock. The location of the nala dam should be chosen in such a way that the water diverted 50 to 100 meters from the dam will spread in the field. To divert the water stored near the dam to the field, a stone wall of 0.60 m thickness should be constructed on the lower side of the dam. This wall should be constructed up to 2 mtr inside both the sides of the nala. From here, both the banks of the nala should be dug to divert water in the field.



*Loop Bunding*

### Do you know?

Bhanjibhai Mathukiya from Saurashtra experimented with the construction of a semicircular dam to overcome the water shortage in the area by conserving water from streams and nalas.

They built a semicircular dam to block this water. In this, several arched dams were built in a row, one by one. The durability and strength of the vertical arch construction used for the construction of the British-era railway bridge was referred to here. The work was completed in just four days, mainly using stone and riverine sand to build the dam. It cost ten thousand rupees. Bhanjibhai Mathukiya has been honored by the President with an award from the National Innovation Foundation for this work.



Such semicircular dams have been constructed in Shirpur taluka of Dhule district in Maharashtra and at Botadwadi, Hantur in Sangli district.

## 7. Farm Pond

Excess running water from the dams is pumped out of the fields by trenches. Instead of removing such excess water from the field, the farmer should dig and store the farm ponds in the field. For this, a pit of about 30 meters long 20 meters wide 3 meters deep should be taken and the sides and bottom should be sealed with a proper slope. Depth of farm pond should be 2 m in saline land area especially in Konkan coast. About 1500 cubic meters of water can be stored in such dug farm ponds. The stored water can be used for agriculture. The government is implementing the scheme of 'farm pond on demand'. (i.e. मागेल त्याला शेततळे)



*Farm pond*

### • Block and seep water by cultivation

Just as water can be blocked by building different types of dams, proper tillage of the land can also blocked rain water and seeping into the soil.

#### A. Tillage of land on slope should be done horizontally

We plow the land before sowing the crop. Some farmers plow without considering the slope of the land. As a result, rain water flows towards slope and more erosion of soil occurs. However, if horizontal plowing is done on the slope of the land, small causeways will be formed in the soil and it will help the rain water to seep into the soil. Rain water that falls in the month of May seeps well in the soil. Further, it was convenient to cultivate the soil and it

could be cultivated in time. If the land can be cultivated on time, the crop can be sown immediately after the first rains. Timely sowing of crop is an important way to increase crop yield. Sowing should be done evenly after horizontal tillage on slope. This retains soil moisture, so crop yields can increase by about one and half times.



*Cultivate land on slopes*

#### B. Crops should be sown in a strip

Horizontal sowing should be done on the slope of the land to reduce soil erosion and to soak in the same place where rain water falls. Due to the crop grows in lines results that some amount of water is blocked. Also, after sowing a few strips of tall growing crops like sorghum and millet, overgrown crops like groundnut and pulses will cause water seeping in the soil. Due to this, crops will get moisture and grows better. Also, the soil in the field will not be carried away.

For example, every 5 to 6 meters (about 15 feet) of plowing should be done at the same level while sowing. After plowing sow tur. Sow groundnuts in two lines of tur or in about 15 to 20 feet of soil within two levels of plowing. Without carrying out rain water it will seep in soil and crops will also get benefited from that. Sowing in strips improves crop growth by soaking the water in the soil.



*Strip irrigation of crops*

When sowing by intercropping method, after sowing two rows of groundnut, one row of *tur* or sunflower should be sown. Sow two rows of *tur* and groundnut at a distance of 30 cm or 12 inches alternately. Such sowing method also increases the yield of crops.

### **C. Improved /Modified cropping pattern should be adopted**

In *kharif* or *rabi* season, if crops are cultivated by intercropping method instead of single crop like sorghum, millet, *tur*, groundnut, wheat, gram at a time, the total foodgrain production increases. In addition, crop rotation improves soil texture. In intercropping system, one row of *tur* is sown after two rows of millet or sunflower. This method can increase crop yield. When using double cropping system, *udid-mung-chawli* should be sown in *kharif* season and sorghum, *kardai* or sunflower should be sown in the soil during *rabi* season. This makes soil texture better. Fertilizer improves texture and promotes good growth of the next crop.

When rotating crops, gram should be grown this year in the land where *rabi* sorghum was grown in last year. Also, sorghum should be grown next year after *kardai* /safflower. It is more beneficial to take bajra or sorghum for fodder in *kharif* season and gram or safflower in the same soil during *rabi* season. .

The water holding capacity of the soil increases due to the use of biochar, coco-peat for crops. Water retention does not require much water and in a way saves water.

### **Do you know?**

#### **Dryland orchard planting techniques for water saving**

##### **1. Planted at root place**

The seed of the tree is sown in a pit without using grafted trees for planting fruit trees. The seed is rooted throughout the year by filling the pit with a mixture of manure, organic manure and soil. When the seedling is formed from the seed, grafting on the seedling is done in the same place. If the plant stays in the same place, its roots will go deep into the soil. This method avoids excess water consumption.

##### **2. Watering directly near the roots**

**A.** This method of watering the plants has been popularized in recent times by placing a vertical pot with a small hole in the bottom of tree or a plastic bottle half-buried near the trunk of the tree. This causes water to seep directly into the roots.

**B.** When watering with the help of sand column, first take a pit as required for planting and bury PVC pipes on two or four sides in the pit. The pit is filled with a mixture of cow dung manure, vermi compost and soil. The buried pipe is first filled with vermi compost and then filled with sand. After some time period, these pipes are removed. Sand columns appear to have formed because of the sand in the pipe. Then when the plant is watered, the water goes directly to the root of the plant and creates moisture there. Due to column this moisture lasts for a long time. This technique is called Climate Resilient Agriculture (CRA).

The water crisis in many parts of the country is becoming more and more serious and in order to reduce the severity of the problem, permanent measures/remedies need to be taken.

## • Remedial plan for water problem

### 1. Water conservation

Water conservation is seen as a permanent solution for drought conditions. Water conservation through watershed area development can solve the water problem permanently. Every drop of rain can be used by water conservation works in various parts of the state. If the policies of well restructuring, deepening and widening of rivers, constructing dams at various places, 'Block water and Seep water' are implemented, the reducing problem of water will be solved permanently.

### 2. Groundwater recharge

In urban and rural areas, groundwater levels are reducing rapidly due to large-scale extraction of groundwater through borewells for domestic use, for agriculture as well as for factories and industries. That is why it is necessary for the government, NGOs and all of us to take the initiative to effectively increase the ground water level by recharging the artesian well (*kupanalika*) and recharging the wells. Groundwater recharge increases groundwater levels and in addition allows proper use of rain water.

### 3. Restrictions for water pollution

Citizens should not perform rituals in rivers, streams, nalas, wells (*kupanalika*), canals, etc. or in the flow of drinking water. Also, the items obtained through it, *Nirmalya* etc. should not be immersed. Water should be

used sparingly. Waste discharged from the factory e.g. Hazardous chemicals, hazardous fluids, sewage etc. Materials should be disposed off in a manner that does not harm the environment, treated and recycled polluted water.

### Internet my friend

Find out more information about the following activities on the Internet.

1. Ralegansiddhi experiment - Padma Vibhushan Anna Hajare
2. Vanrai experiment- Padma Vibhushan Mohan Dharia
3. Water Conservation Experiment - Padma Vibhushan Sri Sri Ravi Shankar.
4. Hiware Bazar- Padmashree Popatrao Pawar
5. Water community experiment - Hon. Rajendra Singh Rana
6. Shirpur Pattern - Shri. Suresh Khanapurkar
7. Jal Dindi Movement - Dr. Yevle
8. Nisargabet experiment - Dr. Upendra Dhonde
9. Nidhal village Development - Shri. Chandrakant Dalvi
10. Jalasamvad - Dr. Datta Deshkar

### Exercise

1. Why is it necessary to implement watershed development program?
2. Write information about the activities implemented for watershed development in your area.
3. What remedial methods are involved in watershed area development?
4. How to recharge groundwater in urban areas? Explain with an example.
5. How can the technique of 'block water, seep water' be made successful while cultivating the land? Explain with an example.

## Unit 2 : Water Conservation

### Chapter 3 : Water Conservation and Public Participation

#### Let's recall.

1. What is water conservation?
2. What does include in water conservation ?
3. Explain any one factor of water conservation ?

#### • Water conservation and the government

The water is most important property on earth. Water is the origin of all living thing. In the life of an organism, water is next to oxygen. Therefore water is called 'life'. Although water is the natural source due to its uneven distribution-allocation, increasing demand and management, have currently being scarcity. Many water conservation schemes are implemented for public utility by the government in India. The schemes are implemented at state and central government level independently as well as it is also implemented with the joint participation of central and state government. The role of Local self-government bodies is an important in implementation for these schemes. For example water power campaign, *Jalyukt Shivar Yojana*, *Mahatma Phule* water conservation planning, *Atal* groundwater planning, water storage planning in the period of Shivaji Maharaj etc.

#### • Water conservation and public participation

Any problem or public work is not successful with the participation of one person or a small group for that, the help (time, labour, skills, financial support etc) provided by the villagers in various forms is important.

To solve such variety of problems, everyone should come together and investigate the problems, do proper planning, to do implementation, evaluate them from time to time and to get rid of the problem it means public participation. Public participation is the original core of development.

Nearly 75 % of rural areas in Maharashtra are experiencing scarcity every year for drinking water and farming. The problem of water is being more complicated instead of relaxing. As a temporary solution to this, the needs are fulfill by supplying water by tanker. But this can not be a permanent solution. Therefore public participation are important to solve the problem of water scarcity.

#### • How to get public participation ?

To increase public participation organize various public awareness workshop, to organize and take the *gramsabha*, labour, co-operate to government employees, *Prabhat Pheri*, essay competition, speech competition and various activities. Youth board, farmers group, women's savings groups, social institutions come together and avoid any claims, group crisis, political tactics are put aside so that water scarcity can definitely be overcome. Large scale water conservation works are being carried out in the universities with the participation of students and villagers under the National Service Scheme (N.S.S.).



Water conservation work and NSS symbol

● **Flow chart of work to be completed through public participation**

How the work of water conservation can be successfully completed with public participation?  
We can see this from the following flow chart.



*Public participation - inclusion and consideration of all*

1. Activity - discuss on needs, importance.
2. to decides goals.
3. to make an outline of action programme.
4. to plan in detail.

**Step I - Public participation planning and preparation of action plan.**

1. Give instructions to everyone
2. To explain the information
3. Distribute the work
4. To do actual action
5. To do control on action
6. To guide
7. To get review of completed work
8. Get feedback on the work done



**Step II - Implementation of planning (Activity proceedings)**



1. Direct evaluation - inspection of work
2. Discuss and report
3. Give information on completion of activities to others.
4. Acknowledgement - Congratulations to the participants.

**Step -3 Evaluate the activity and check the productivity.**





### Try this.



At the school level, the National Green Army has been established in the state. Through them mainly tree/forest conservation work is done. What can be done for water conservation through National Green Army in your school, discuss with your teachers and implement it.

- **Some examples of public participation**

#### 1. Alchemy of Public Participation in *Hiware Bazar*

Under the SAMRUDDHI Mission, efforts are being made through the National Rural development society in *Panchayat*. Special efforts are being done by *Padamashree* Popatrao Pawar and various administrative officer in the rich *panchayat* like *Hiware Bazar*.

Watershed development began in 1995 in *Hiware Bazar*. *Gram Sabha* called and approved the work of watershed area development and rural development. After the start of work, all the works were completed according to the plan that has been planned in the three years. In those works (The water flowing down from the hillside) parallel trenches dug into the ground, and seeps into the ground, dams were built in the streams of water to block the flow of water, diversion of this water into a seepage pond or divert into a pond after completing all the works significant levels of water in the village wells increased. As a result, enough water became available for farmers in the village for conservation irrigation during the *kharif* season. As well as some of the area under cultivation in the village started getting benefits of irrigation for *Rabi* season crops. In *Hiware Bazar* village, due to watershed development work about 400 mm of rain water falling every drop began to come in utilization. There were 97 wells before water conservation and soil conservation work was done. But the water level in it had gone deeper than 100 ft. After completion of water conservation and soil conservation work groundwater level increased and it was

possible to dig 132 new wells for irrigation to farmers. There are total 229 wells in village. In these wells the water level increased upto 50 ft. Electric pump are setup on all wells to draw the water. Because of these changes protective irrigation facility has become available to all cultivated areas in the village cultivation. During *kharif* season it was possible to sow in all the land. During the *rabi* season, about 220 hectares of low water irrigated husk (*Bhusar*) crops can be grown. Thus the density of the crops is 128. Agricultural productivity, per hectare production has almost double in the past.



*Hiware bazar : Public participation guidance session*

*Hiware Bazar* village has decided cultivation-structure of the village considering the availability of available natural resources. The *Gram Sabha* passed a resolution to ban the digging of new bore wells in the village. It was mandatory to use water from bore well water reserve for domestic use only. That decision of the *Gram Sabha* provides pure drinking water to people. Since the water from bore wells is reserved for domestic use only, the groundwater uptake is less than the amount



*Dam of Hiware Bazar*

that is filled in every year. This process has led to a continuous rise in groundwater levels.

The Government schemes are welfare when coordinating and agreeing leadership and public participation and every *panchayat* in the country is ideal and if we work with social spirit, every *panchayat* in the country will become ideal, this was realized while working in this village.

## **2. Shirpur pattern and unique public participation**

Although there has been no rain for two years, there is no drought and heavy rains do not cause floods even if it falls on the same day, such alchemy is not only done in one village of Dhule district, but in about 80 villages due to Shirpur pattern. In Shirpur Taluka a unique experiment in water conservation started since 2004 and continues to this day by the effort of groundwater expert Shri Suresh Khanapurkar and with the help of local people's representatives. It is permanent solution of drought and floods. This Shirpur pattern has been implemented successfully in 20 districts of Maharashtra, approximately 200 villages of Madhya pardesh, Gujrat and in some villages of Karnataka region. Till today in Shirpur taluka 235 dams of cement are built in 80 village. At the top of each embankment up to 500 meters, the *nala* was made 80 to 100 feet wide, and 25 to 30 feet deep. The farmers are donated 60 hectare land as public participation for this widening and for new roads. Rural development has been achieved in the true sense in Shirpur taluka with the help of confluence of technology, support of public

representatives and selfless people participation. Due to this deeping and widening 31 billion, 66 crore, 70 lakh litres of water has been blocked and seeped in these 235 dams.

### **Features and Benefits of Shirpur Pattern**

- There is no land acquisition, displacement and rehabilitation anywhere. Floods have been permanently curtailed due to storage and merge of excess rain water. Drinking water scarcity permanently finished due to this programme implemented nearly each and every village. Abundant water is available for farming. Water Tanker has been closed permanently. Scarcity of water permanently curtailed due to abundant water.
- It takes 3 months to dig and build one dam. The 500 meter long and 20 meter wide drain has been excavated to depth of 6 meters.
- The land has become fertile due to spreading soil from drain excavated. Binding has been done by a fine soft stone. 52 km roads of village and the farm roads are done by using of thick soft stone and hard rock.



*Shirpur pattern*

- The question of electricity has been resolved by offering diesel engines at discounted rates to farmers where electricity is not available.
- Approximately 24 hectare land is received water perennially due to a dam.
- The trouble has stopped forever due to flood damage and drought.
- Since it is a decentralized water conservation, there is no need to acquire land for the cost of canal anywhere.
- Minimum 70 % perennial irrigation is possible in each areas. All the people who came to the city for employment they have returned to the village due to the employment will be available in the village.

An accordance with the above details, the project work has been completed in 70 to 80 villages of Shirpur taluka in Dhule district since 2004 to till today. Total 235 cement dams are built. No tanker in Shirpur taluka in last 20 years. The percentage of irrigation is 80%.

### 3. Paani Foundation

Paani foundation is a organization based on the principle of non-profit which is established in 2016. The team of the TV series *Satyamev Jayate* by actor Aamir Khan took the initiative for the people of rural areas in Maharashtra, to make them able to face severe water scarcity. Water shortage is a man-made crisis. So people should try to get out of this crisis. Hence, to join people to this campaign to ward off drought, to inspire them and to train them by providing a medium of communication are the goals of Paani Foundation. At present Paani Foundation provides training on water conservation, leadership qualities and socialization/organization. In 2016, 'Satyamev Jayate water cup' a unique competition was organized as an inspiration to the villagers to put into practice the skills they have learned about

watershed management in the training. The work done by Paani Foundation is an example for water literacy, public participation water awareness.



*Public participation work of paani foundation*

### 4. Indo-German Watershed Development Project-Nidhal(IGWDP)

Nidhal is a village in the drought prone region of Khatav taluka in Satara district. The geographical area of the village is 2001 hectares and the population is between 5000. Tankers had to supply drinking water to the village till the implementation of the watershed development project. Under the leadership of Chartered Officer Shri. Chandrakant Dalvi, the overall development of the village has been done since 1983 on the strength of public participation. With the help of NABARD, the Indo-German Water development Project was implemented on the entire 2001 hectare of the village from 2006 to 2011. Due to completion of all these works for agricultural treatment and drainage line treatment, the entire water (every drop of water) of the village has been blocked by various treatments under the watershed development. Public participation is a key feature of this watershed development. The total cost of the project in 2006 was Rs 1.46 crore. As many as 20 % of its people participation has been reported. As per NABARD rules, 17% people participation was expected while the village has given 20% people participation. In this, each account holder farmer has contributed 20 %of the

expenditure incurred on his land. Those who could not afford the labour (*shramadan*) contributed the same amount to the Watershed Development Committee. While implementing this watershed development project, the five principles of grazing ban, axe ban, sterilization, drug ban and *shramadan* have been implemented. Their strict implementation has been done due to public participation. The following are the major features of Nidhal village watershed development and water conservation project.

1. This project has been implemented by the 'Nidhal Watershed' Development Committee of the village. This is the first watershed development project in the country implemented by a village watershed committee without an NGO. This is the greatest example of public participation.

2. Soil and water conservation treatments were carried out according to the formula from top to bottom. To the north of the village is a steep hill. The top of the hill and the steep slope are covered with plantation by doing stone bunding and contour bunding. It is the first watershed project in the country to be implemented on a steep hillside.

3. There are four streams in the area of Nidhal village and a series of cement dams are being built on them. The last embankment near the outlet of the watershed and the upper embankment at the end of its backwaters were constructed, using this formula 70 cement embankments were constructed in all the four streams. Out of this, 33% public participation has been given by the beneficiary farmers in the cement dam constructed under NABARD. The combined length of all the four streams is 28 km and when all the dams fill due to rain, a water column of 28 km length is erected on the outskirts of Nidhal village. Some dams store water till the end of April.

4. Twenty five kilometers deep CCT has been dug at the bottom of the hill under *Jalayukta Shivar Yojana*. This work was done on the basis of government funding and public participation.

5. Tree plantation : More than one lakh trees have been planted in the area of Nidhal village

since 2000 through various government schemes and public participation. Grazing ban, axe ban, increase in groundwater level has resulted in more number of naturally grown trees than planted. The barren area of the village is now green due to tree planting and conservation.

6. The total area of Nidhal village is 222 hectares of forest land. Joint forest management program for forest development is implemented since 2006 and the Village Forest Project has been in operation since 2017. After the implementation of this project, 222 hectares of barren forest will be converted into forest. With the effective implementation of watershed development projects, repair of old seepage ponds and earthen nala dam repairs and removal of leaks, ground water level has increased drastically and Nidhal has now become a water rich village. Changes in cropping patterns, universal use of drip irrigation and sprinkler irrigation under micro-irrigation in water management, dairy business as a side business, women's saving group movement and sufficient financing to farmers



*Position before public participation*



*Alchemy of public participation*



*Nidhal village area*

through various financial institutions, this has started the successful journey of the village towards economic revolution.

### **5. Construction of wells and dams through public participation**

Topical water conservation is the key to successful water conservation in mountainous areas. Villages in such areas are often situated on a hill or plateau. So the water problem becomes more serious. The water is in deep valley or in a small stream in the valley. Since it is also on a slope, the water flows rapidly downhill and the ground water level goes down and the wells dry up. It is a major cause of water scarcity in many places. Successful water conservation in such places is based on the path of sustainable success of on-site water conservation planning and its completion with the participation of the village people. In this, water conservation plan is prepared by surveying the village. This work is then completed through the joint efforts of the government, NGOs, industry experts and the villagers. Government to give all legal permission, NGOs as a link between all, industries for financial cooperation, experts for proper planning and monitoring of actual work and villagers volunteering for the actual work are planned. Blossom Charitable Trust, Thane with financial support from Rotary Club and other donors, designed and completed the scheme by Dr. Umesh Mundalye. The villagers participated in it and helped in the construction of wells.

Thus, with the help of various NGOs and industries, over the last 20 years, villages in the states of Maharashtra and Goa have

successfully implemented water conservation schemes, to stop tankers and different grow crop to bring prosperity to the village, save the lives of women and girls and stop the migration of villagers. These things are being achieved only through public participation.

The well at Badalpada, Khodala district Palghar used to dry up in March. 550 people depended on this well. They have to wander three and a half months of the year to fetch water. With the participation of the people, the construction of an underground dam provided water to the well throughout the year. As the pump continued to run throughout the year, the men's and women's hardships ended. Now the villagers are thinking of summer crop (vegetable). This is the beginning of development.



*Construction of well through public participation*

### **Women's participation in water conservation**

With the participation of women, many schemes have been planned and implemented in India. To give a closer example, the village of Kendur in Shirur taluka of Pune district can be given. The Government of Maharashtra has started a Water Literacy Center through which training has been imparted to the women of this village. Taking advantage of this, they created a water balance sheet by taking a round around the camp and carrying it out shoulder to shoulder with the men. In the last few years, there have been agitations in the village due to declining rainfall and it was demanded to get water from Kalmodi dam. The women overcame the water problem by starting this work, claiming that there was as much water in their village as was demanded.

### Use your brain power.

In diagram mention the characteristics of public participation.

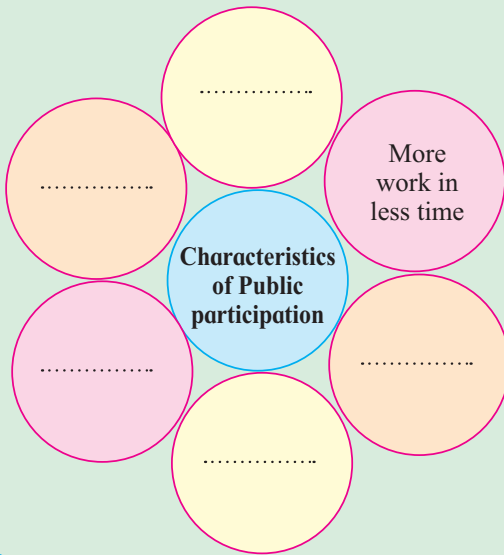

### Try this.

On the basis of table given in the lesson of water conservation from public participation prepare street play and present it.

### Internet my friend

Get information of following topics from internet and present in the classroom.

1. Ideal village scheme
2. Water conservation from public participation
3. Various government water conservation scheme.

### Do you know ?

Some villages are on the bank of bay and ocean in Alibagh and Pen taluka in Raigad district. Due to the tides coming from the sea, saline water come on the land and spoils the fresh water as well as land. Therefore it is necessary to construct dams on the creek and repair it time to time. For this *Jole Sanghna* established in each and every villages. Preparation for the next season starts after the end of the monsoon season. All the members of the association decided how long the dam according to the area of land should be maintained. The work of strengthening the dam is completed by the month of March. Black sticky soil is in the field near creek. The soil is dug with the help of 'Pensan' tool which is made from wood and to apply on the dam. Leader of association observed the work at the end of March. If the work is not completed then extension is provided to complete the work in the month of April. The one has not completed the work on time has to pay fine to association as punishment. Incomplete work completed from collected amounts.

The continuous construction of such dams is done through this association. For this, association members and the villagers use developed tidal schedules based on traditional knowledge. The dams which are weak due to crab burrows, tides, and heavy rain, repair urgently. All this work has been done at the level of association through the public participation.

### Exercise

1. Why public participation is important in water conservation activity ?
2. Write down the information of an activity of a water conservation which is completed through public participation in your area. Write its objectives ?
3. Which are the objectives of public participation?

## Unit 3 : Water Management

### Chapter 1 : Water Condition and Water Challenges in Maharashtra

#### Let's Recall.

1. What is water Management?
2. Which factors include in water management ?

It is said that only that can be measured which can be managed. So If you want to manage water, first its total availability should be understood. So let us see, how much water is available in Maharashtra state ?

#### • Maharashtra State : Rainfall

The Maharashtra state is in tropical region. The Arabian Sea which is in west of Maharashtra, latitudinal extent of Maharashtra, southwest and northeast monsoon and the eastern plateau region affects the climate of Maharashtra. Maharashtra receives the highest rainfall of 85% from southwest monsoon from June to the end of September. Monsoon starts to retreat in the month of September and by October, the monsoon is retreated completely. Therefore October is called 'Transitional Period'. It rains from northeast monsoon from October to January, it is called 'Retreat monsoon'. If annual average rainfall is approximately 1360 mm of Maharashtra State, then also the rainfall in different region is varied. When rains occurs on the *Sahyadri* the winds begin to blow eastward as a result their evaporation rate increases, because of this rainfall speedily decrease on plateau and the region where the rain shadow is formed is called a 'Drought region'.

Annual rainfall in *Konkan* is 2000 to 3500 mm and in the state of Maharashtra 55% of the water is available for human use in *Konkan* region. Instead of *Konkan* in western Maharashtra, *Marathwada* and

*Vidarbha* have only 45% water available for human use. The percentage of rainfall in the eastern in rainfed region part of *Sahyadri* are only 450 mm and this ratio is increasing up to 1000 to 1400 mm in the eastern part of the state.

A drought region of Maharashtra area is approximately 61,600 sqkm. The rainfall is 300 to 500 mm. About 20% of the total area of Maharashtra falls in the drought region which is 6% of the total population of Maharashtra State.

#### Search this.

1. Which are the five major drought prone districts of Maharashtra State?
2. Which are the five major rainfall districts of Maharashtra State?
3. Which are the five districts where average annual rainfall is maximum in Maharashtra State?

#### Internet my friend

1. Collect the map showing, the major divisions of Maharashtra according to rainfall and land type.
2. Present the information through Power Point presentation to the class with the help of the obtained map.

#### • Availability of Water in Maharashtra:

Maharashtra receives an average of 5,782.8 TMC litres of water per year through sufficient rainfall, which is 14.59% of India's total water availability. Out of this 76.91% it means 4,447.8 TMC water was available for use. It means that 29.10% of India's water was available only in Maharashtra.

In this way we get rain water for direct use of rain water in the form of surface water storage and for ground water reserves.

1. **Direct Use** : Used when it rains.
2. **Surface water reservoir** : Reservoir and ground water storage of river basins, ponds, dams, bands, *sarovar* and lakes etc.
3. **Ground Water reservoir** : Water that seeps into the soil during rains and when it is blocked and available for use through brooklets, wells, tube wells and canals etc.

Although **surface water** and **ground water** are considered to be the two main sources for human consumption, they are not really two different sources but are interchangeable. Therefore, in terms of planning they need to be accounted together. However, when the consumption is less than the availability of water, it is possible to think and keep separate accounts of water. But now the water consumption is increasing faster than the water availability. It is necessary to consider the interdependent availability of both the states together.

#### • **Water Challenges Facing by Maharashtra state**

Geographical area of Maharashtra is about 9.37% of the country and around 14.59% of the total water resources in India is available for Maharashtra. However, the state is experiencing water scarcity and frequent, droughts. In short Maharashtra has a naturally abundant water resources but due to lack of proper planning and management the water problem in the state is getting worse. Drought situation is very dangerous in the state, about 38.63% of the villages in *Marathwada* are declared as drought affected areas. Moreover, burning crops in drought prone area, desolate orchards, the affordability of animals with humans for drinking water, animal camps this picture is visible as soon as the rainy season is over. Some main reason are given here.

### 1. Unequal Distribution of Water Resources

The unequal distribution of rainfall is in the state of Maharashtra and more than half of the rain falls in *Konkan*, while about 126 talukas in Maharashtra have permanent drought. The *Sahyadri* range is at the west of Maharashtra blocks southwest monsoon winds from the Arabian Sea, resulting in 2000 to 3500 mm of rainfall along the *Konkan* coast 500mm to 750 mm and 1000 to 1400 mm in western Maharashtra and *Vidarbha* to the east of the *Sahyadri* range.

### 2. Need to effective planning

Considering the rainfall figures for the last 100 years the average rainfall in the state is not very low 14.59 % of the total water in India is available for Maharashtra and 29.10% usable water of the country is available in Maharashtra alone. But with more than five-times increase in population, green revolution in agriculture, development of infrastructure, industrial progress, the demand for water is increasing tremendously, but still about 80.00% agriculture land in Maharashtra is dryland. Apart from every year about 1500 villages and 4305 settlements in the state are facing shortage of drinking water. Therefore, water resources need to be planned and managed more effectively.

### 3. Ignoring ground water and drought crisis

The availability of surface water resources depends mainly on rainfall, topography and geological conditions. The diversity of the topography of the state is  $\frac{1}{3}$  of the total area is mountain,  $\frac{1}{3}$  is drought prone and  $\frac{1}{3}$  is excess rainfall area. At the same time, due to its unique geological structure (92% hard rock), fluctuations in rainy season and area deviation due to such complex natural conditions, there is a great diversity in surface and groundwater availability in the state.



Maharashtra has 40.58 lakh hectares land under irrigation. The contribution of surface water is 11.63 lakh hectares. The remaining 28.75 lakh hectares area is dependent on ground water. This mean that almost 70% of irrigation is dependent on water. In the country too, the rate is almost the same. In short, the rate of dependence on ground water for irrigation is very high. More than 85% of the ground water is used for irrigation, up to 10% for industrial use and up to 5% for drinking water. Today there is no official record of number of bore wells which is available for use except for drinking water in the state. But the Maharashtra water and Irrigation commission has estimated that their number should be equal to 20 lakhs as same as wells. A large amount of groundwater is being pumped through this channel.

#### **Think about it.**

- If the ground water abstraction continues like above, what will be the future situation of Maharashtra?
- What measures would you suggest to control the pumping of ground water ?

#### **4. Increasing demand of Water for Civilization and Industrialization**

Rural population is migrating to urban areas due to growing population as high living standards, employment and water scarcity. Because of this use of drinking water, industrial and domestical use this has led to a huge increase in the demand of drinking water in urban areas. Of the usable water resources in the state, more water was being used for irrigation in the last decade, but now the use of water for no irrigation is on the rise. At present, industries in the state need 194 crore liters of water per day. Out of that 128.6 Crore liters of water is used for industrial purpose only. About 65% of the total water used for industrial project

is supplied from the irrigation project, 34% water is available in industrial corporation project and 1% water is available from other sources.

#### **5. Inadequate utilization of Irrigation capacity**

Today total 3910 state level irrigation project are completed (87 large, 297 medium, 3526 small). Their total productive and useful storage capacity is about 48,705 million cubic meters) (1720 TMC) and 40,897 million cubic meters (1445 TMC). The total irrigated area under crops in the state has increased from 6.48% to 20.60% during 1960-61 to 2010-11. Besides innumerable irrigation project works are incomplete like canals, distribution the irrigation capacity of the projects is not being fully utilized due to delays in their work. Delays in completion of project, on the one hand, increase the cost of projects and on the other hand do not bring the expected growth in the irrigation sector. Also, various irrigation project storage capacity is reduce due to its sediments in irrigation project.

#### **6. Improper and excessive use of water**

In a drought village in Maharashtra, people have to search for drinking water. In some cities the tap water is provided once a week, fortnightly or once a month in some places. In some cities of state per capita 250 litres of tap water is used excessively. Due to the increase in population of the city and excessive use of water, the reservation of water use for urban areas is increasing and the problem of agriculture and drinking water in rural areas is becoming serious. Farmers in irrigated areas are still provided excessive water for sugarcane crop. As a result water is wasted and at the same time excess salts accumulate in the top soil, making the soil saline and barren. This results in a decrease in crop production.

## 7. Water pollution

At present, in Maharashtra state, water pollution is the main water problem. Waste water, chemical substance, domestic waste water, sewage from industries and factories are discharged into rivers, brooklets and runnels etc. Washing clothes, animals, vehicle, ritual, bone ash, immersion etc. are the main factors which causes water pollution. The problem of water pollution has become so serious in Mumbai, Thane, Pune, Aurangabad, Nagpur as well as other cities in the state that in some places rivers, runnels and brooklets have taken the form of gutter. Due to water pollution many harmful substances and chemicals enter in the human and animal bodies through drinking water and causing many diseases. When people drink the polluted water, they suffer from Jaundice, Thyphoid, Cholera, Skin disease and occasionally leads to death. It is imperative to address this issue.

### Observe and discuss.

Observe the various events shown in the given picture and discuss in the class about water condition use and problems.



- **Remedies on current water crisis**

Efforts need to be made to alleviate the water crisis in the state and provide adequate water to the agriculture, industries and urban areas for consumption. Extensive public awareness is required to increase with the help of public participation in water conservation, ground water recharge, purify the polluted water with the help of process, drip irrigation, sprinkler and micro-irrigation, full utilization of irrigation, water auditorship, water literacy campaign etc.

**Some successful examples of current water crisis remedies**

**1. Devsane (Manjarpada) Project :** In Maharashtra most of the rainfalls is in the *Konkan* and then the water is carried to the west. Small dams were built on the top of the *Sahyadri* mountains before the water started flowing downhill to the west. In Dindori Taluka of Nashik District the water which flows towards west direction is diverted to the East. The innovative project has been implemented for the flowing water of the western channel rivers for which about 10 km of tunnel has been constructed and the water has been diverted to the east.



*Devsane (Manjarpada) Project : Tunnel*

**2. Use of Sludge from lake and dam:** Lake and Dam water capacity is reduce due to sludge accumulation, such sludge has been

removed from Buldhana district and other places in the state and used for highway and agriculture. This helps to increase water reserves. The government from time to time allows farmer to free removal of sludge from dam and lake. This makes the farm fertile. Also water reserves of dams and lakes increases.

**Do you know?**

**Experiment on Khadakwasala dam near Pune city.**

The water storage capacity of Khadakwasala dam, which was constructed in the course of Mula river, was greatly reduced due to siltation of the surrounding area. Green Thumbs Pune has played an important role in preventing the new sludge is not carried in again, and let it be the same again, through public participation. This organisation started this work with the help of military, school and college students, local residents and industrial organisations in Pune and it is still going strongly today. As it is no longer possible to build new dams to augment the country's water reserves, the project has also emerged as a model for such work to be done in various river basins in the country. For this work colonel Suresh Patil, a retired army officer and his colleagues took an initiative and set up the project through establishing the Green Thumbs institute.

**3. Inexpensive Basalt/Pashan lakes:** We see a lot of construction going on around us. Road works are in progress. The stone required for this is made from rock. A machine that converts a stone into a fine

mortar is called a crusher. The rocks mix into this crusher are obtained from the mines. When the rock take away from the mines then a large deep pit is formed at that place. It is called a stone quarry. You have seen many of such stone quarry. If stones are properly removed from such quarries these quarries can became reservoirs. The use and storage of water in the rock mining is called Basalt Lake.

Example-In rural areas about 160 brass macadam are required for a 1 km long, 6 inch thick and 10 feet wide raw road. About 144 brass pits have to be dug for this. Its water reservoirs capacity is 4 lack litre. If a 5 km road is constructed, about 20 lakh litres of water can be stored in the required rock pit.

In this rock ponds rain water stores naturally. Also water flowing down from the hill during monsoon is stored. The water in this *Pashan* lake is processed properly and used for drinking water. Proper mining of stone quarries will result in conversion of innumerable quarries into *Pashan* lake. The following points should be kept in mind while removing stones from a quarry.

- a. Choose a suitable place with a slope.
- b. The quarry should be dug six meters deep and shaped it properly.
- c. There should be a road having slope less than  $45^{\circ}$  to enter the mine.
- d. For safety, sharp stones should be removed and the mine should be fenced.

In this way new quarries can be dug properly or old quarries can be repaired and *Pashan* lake can be constructed at low cost.

### Basalt/*Pashan* lake -

#### Borghar Haweli Tal. Dist. Raigad

Here is the hostel of social welfare department. In order to overcome the water scarcity, the officers, Mr. Pramod Jadhav and Mr. Sandeep Kadam cleaned the old mines in the area by removing the remaining stones. Nine thousand rupees expended for this work. Now there is no need to use tanker after using this water. We can see here greenery in the vicinity of hostel due to availability of water.



Stone quarry

### Collect information and discuss.

1. Collect information about the dam and pond nearby to your area, village or city from which you get water.
2. Visit the water distribution organisation and get current information about water condition of that area.
3. Get information on the remedies on the water crisis in your area.

### Use your brain power.

1. How we can help to use water sparingly?
2. What are the water wasting elements around you as well as the places where water is wasted? How can this be overcome?

### Internet my friend

1. To know the water condition of the state get information about rivers, numbers of dams, water storage capacity, water reservoirs, catchment area etc.
2. Get information of the dam in your area (with map). Present information of action to be taken in the context of water management and power generation.

### Collect information.

Visit the stone quarries in the area where you live. Create a report on, what can be done there regarding water storage.

### Exercise

1. What type of wind causes rain in Maharashtra?
2. What is the drought prone region?
3. How is distribution of available water in Maharashtra? Write in detail.
4. What are the remedies on current water crisis ?
5. What are the causes of drought prone condition in Maharashtra and suggest remedies on it.
6. Now a days water management is very essential. Write your opinion on this.

## Unit 3 : Water Management

### Chapter 2 : Irrigation

#### Can you recall ?

1. Why is water so important ?
2. By which methods water is supplied for agriculture?

#### • Irrigation

The process of giving excess water to crops other than rain water is called "Irrigation." Water from dams, lakes, canals or other sources of water, river water, ground water etc is used for irrigation. One thing to keep in mind, when water from all these sources is used for irrigation, actually very little amount of water is used for actual cultivation or farming, the amount of water that evaporates is very high.

#### Can you tell ?

1. How is the diversity in agricultural irrigation in Maharashtra? What are their causes?
2. Why it is necessary to change or improve the agricultural irrigation system?

Out of 450 horticultural districts in India, 44 districts produce about 50% of the country's food grains. Out of these about 14 districts have more irrigated area and about 25% yield is obtained from it. From this figure, we understood the importance of irrigation. India have fifth rank in the World according to the water distribution system and if we think about the irrigated land India's rank is 1st in world.

#### • The purpose of Irrigation

1. To make water available for taking crops in seasons other the rainy season.
2. Successfully harvesting more than one crop in a year.
3. To make available adequate water for cash crops.
4. To get higher yield per hectare through proper irrigation.
5. To do protected farming by providing reliable and sufficient water.

#### • Types & Methods of Irrigation

**Main method of irrigation** – Main irrigation methods in Maharashtra are as follows

1. Watering from the surface of the land.  
Here, furrow (*sari*) and bed (*wafa*) method is used.
2. Spraying water from certain height on surface of land.

In this sprinkling irrigation method is used.

3. Watering near the roots of plants.  
In this drip irrigation method is used.

#### Types of Irrigation in Maharashtra

##### 1. Well irrigation

In well irrigation different tools are used to drain water from the well.

**Mot :** *Mot* is made from the animals skin. Which is like sac/bag with narrow opening. It drains the water from the well with the help of ox and the large amount of water provided to the field with the help of *mot*. There are two types of *mot*. One is trunk *mot* and second one is without trunk *mot*. The water can drain out from 15 to 20 meter deep well with the help of *mot*. This skin *mot* lasts easily for one year if dried after using the *mot*.

Over the time iron sheet *mot* is used. At the bottom of the *mot* hinge door is present.

If the iron sheet is painted and the hinge is lubricated, then this *mot* can last for five years.

These two types of *mots* are large and used to drain 125 to 200 liters of water.



*Irrigation by Mot system*

### Do you know?

Chandarkant Pathak from Pune has created easy pump and other pumps with the help of energy of Bull. He has been awarded on behalf of National Innovation Foundation by the President of India.



**Chain Pump :** A chain pump system consists two large wheels connected by chain. Buckets are connected to chain. One part of the chain is in water. By rotating the wheels the connected buckets are filled with water. The chain lifts them to the upper wheel, where the water from the buckets is transferred. The chain then carries the empty buckets back down for refilling.

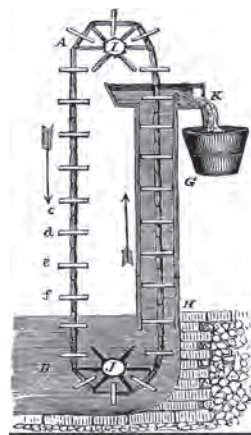

*Chain pump*

**Dhekli :** Bucket is connected to the pole with the help on rope of one side. Then, a heavy object having same weight is connected to the another side to obtain water from well. This pole is used to draw water.

**Rahat :** In this method water is drain out with the help of cow or oxen. A large wheel is installed on the well. With the help of cow or oxen, wheel rotate and water can be drained out from the well.



*Rahat*

Some of these irrigation methods and tools are disappearing now. The current and popular methods and tools are as follows.

## 2. Pond Irrigation

In Maharashtra, pond irrigation proportion is near about 15%. Different types of pumps are used to drain water from the lake. The pump has to be selected according to how much water and from which depth it is to be drained. Just like Submersible pumps work completely under water. The pump and motor is covered with water proof material. In this, Water Pump pushes waters to the surface and it has better efficiency than other pump.

### 3. Lift Irrigation

In Maharashtra, the area of 88 % of irrigation is occupied by lift irrigation. If the water needs to be provided to land at higher level then it has to be pumped out from well, river or water reserve using pumps. For this oil engines and electricity pump are used. In some places solar energy pumps are also being used extensively.



*Pumping of water by pump*

### 4. Drip Irrigation

Depending on the quality of soil, variety and nature of crops, proportion of water evaporation, a network of polythene tubes is spread and roots of plants are irrigated drop by drop, this modern method of irrigation is called **drip irrigation**. In this method, the crops are irrigated slowly than the rate of water seeping in the soil. Maharashtra is only state in India where drip irrigation is done near about 60 %. In this method, the water is not provided directly to the field but it provided directly to the crop. So it slowly dripped into the root of plants and thus water, soil and air are coordinated with the roots of the plants. Therefore water is given at minimum speed and its seeps around the roots.



*Drip Irrigation*

### Benefits

1. In this method, if we provide water in equal proportion and as per the need of crop then the crops grows rapidly. Production increases by up to 20 to 200%.
2. The water saves about 30 to 80 %. Extra water can be used for other crops.
3. Water does not accumulate or carry away and it does not cause soil erosion, as it is given properly.
4. The drip irrigation method can be used in saline or dryland soils.
5. In the method of irrigation, no need to flat the land of uneven slopes.
6. In this method, the expenses are saved approximately 30 % to 35 % due to provision of liquid chemicals through pipe lines. This method gives the same amount of fertilizer to all the crops.

### Do you know?

In 1959, the first experimental system of drip irrigation made by expert Simcha Blass and his son Yashayahu from Israel. In 1960, they developed this method and register the patent.

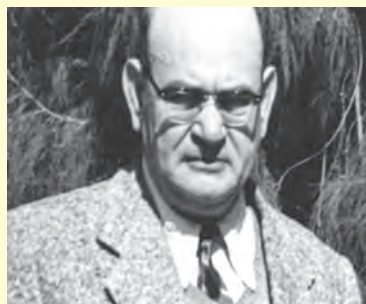

*Simcha Blass*

### 5. Sprinkler Irrigation

Sprinkler irrigation can be used efficiently in areas of low water. In this method, sprinkler spreads water on the crops as like rain water through a thin hole (sprinkler nozzle) i.e. connected to the aluminium or pvc pipe.



This allows the nozzle to rotate in a circular motion at a certain speed. Considering the depth of the roots of the trees, only required quantity of water can be given by sprinkler irrigation. This irrigation can be used in Wheat, Gram, Sunflower, Sugarcane, Corn, Groundnut, Tomato, Cabbage crops as well as for nurseries.



*Sprinkler irrigation*

### **Benefits**

1. Sprinkler irrigation is useful for soils where water infiltration rate is high.
2. *Sari, Varamba, Chari* are used for carrying water in the field for which cultivated land is used but in sprinkler irrigation system, cultivated land is not used in this way.
3. Water is saved, erosion of soil does not occur.
4. Insects-diseases are washed away by the sprinkler irrigation.
5. It reduces labour costs.
6. Like drip irrigation, liquid chemicals can also be used. This results in efficient and sufficient use of fertilizers.

### **6. Canal Irrigation**

In Maharashtra, after wells, water is irrigated through canals. Approximately on 23% of the land this type of irrigation is used. The water is provided to cultivation land from main water storage through canal. The canals are lined with concrete, bricks or stone to prevent erosion of soil as well as leakage of water.



*Canal Irrigation*

### **Internet my friend**

Get the detailed information of canals in Maharashtra state with the help of internet with reference to number of canals, source, area under cultivation etc.

### **• History of water irrigation**

The most important part of human evolution is agriculture production and subsistence. Humans tried to increase food production by experimenting with natural soil fertility, hybrid seeds, modern crop methods and modern agriculture technology. In this, water irrigation is a very important experiments. The world's oldest irrigation remnants are found on the banks of Nile River in Egypt. Scientist estimated that the 110 mtr long and 12 mtr thick stone dam was built 5000 years ago and blocked water was being used for drinking as well as for agriculture.

Most of the Kings had implemented different schemes of water supply to agriculture in their Kingdom. The best example of this is the attempt on the Kaveri River in the second decade. The King Ghyasuddin Tughlak (1220-25) had built canals with his own money. Also, Feroz Tughlak (1351-86) had built various types of canals. In the south India, the emperor was implemented these type of schemes in the 15<sup>th</sup> century in Vijaynagar. A best example is of dam Radhanagari in Kolhapur district established by Chhatrapati Shahu Maharaj.

In 19<sup>th</sup> century the British government brought a lot of development in the field of irrigation. Large and costly projects like east *Ganga* canal, *Baridob* canal, canals on *Krishna* and *Godavari* rivers etc. were constructed. In 1868 the government increased canals like Sirhind canal, sub Ganga canal, Agra canal, Mutha canal, Periyar dam, Swat bandhara, Soliyag canal, Chenab and Singhni canal, etc. were constructed. In the middle of the 19<sup>th</sup> century, they largely focused on irrigation sector. In this period *Betwa* canal, *Nira* left canal, *Gokak* canal, *Mahaswada* canal, *Rushikul* canal foundation was laid. As an effect of this, at the end of 19<sup>th</sup> century total 132 million hectare land was under irrigation. 45% area was irrigated through canals, 35% through wells, 15% through lakes and 5% through other sources.

#### Do you know :

- The origin of water irrigation found in Inamgaon, tal- Shirur dist- Pune Maharashtra in sub continent of Asia. In the stone and Iron age, stone-soil dam have been found near to this village and it is connected with many tributaries of *ghod* river, It is estimated that after the flood situation the water is blocked, the blocked water is then used for irrigation.
- Irrigation remains are found in the culture developed along the Indus River. According to a reference given in the '*Rigveda*' water was given to the trees in the banks of river by constructing the small walls around the trees. (Rigved 6.1.7) from this it can be concluded that the tradition method of irrigation from the land is more ancient than the use of well or ground water.

#### Collect information and discuss.

Collect information about how water carries without traditional external energy.

1. Solar energy pump
2. Pump depend on wind energy
3. Cycle method
4. Hydrum method

#### Exercise

1. What is irrigation? What are the main objectives of irrigation ?
2. What are the main types of irrigation?
3. Which district is leading in drip irrigation in Maharashtra? What are the reasons?
4. Drip irrigation is mainly used for which crops in Maharashtra? Why?
5. What are the components of drip irrigational set? What are the benefits of the method of drip irrigation?
6. Compare drip and sprinkler irrigation method.
7. What kind of material is used for sprinkler irrigation?

## Unit 3 : Water Management

### Chapter 3 : Water Acts and Rules

#### Can you recall ?

1. What is done for water management ?
2. Why rules, laws are important ?

#### • Need of Water act and rules :

The availability and proper use of water resources is the backbone of human development. With the growing population, the world's demand of water is also increasing day by day. The world population was 100 crore only in year 1750. It was 250 crore in year 1950. It's became 500 crore in July 1987 and its became 600 crore in year 2000. The prediction is that 800 crore in year 2025, so it will be 1000 crore in the year of 2050, but the area of earth is constant, so that generally the availability of water will remain stable. As 71% earth's surface is covered by water, although 1% of fresh water is useful to plants and animal on earth surface for drinking. On the other side, with growing population availability of water is decreasing per capita.

#### • Water dispute with few example :

##### A. Water disputes over water distribution :

Water availability is decreasing due to growing population, industrialisation, and manufacturing. There is a dispute for water use in two countries or state. In last 50 years at international level there have been 1831 compromises agreements done. In future, as called the third world war can be occurred in 21st century due to water. At present, the water problem become very intense in 60 countries in the world. Water disputes are created in many countries. The number of water disputes are growing due to growing population and increasing demand of water. Because of this the water conflict is unavoidable in 21st century.

#### 1. Water conflict between Arab nations and Israel :

In last five decades this water conflict continues. Jordan river is life-giver in Israel. Conflict is currently continue between Israel and the Arab nations as the Israel government seeks to make full use of the water of the Jordan river in the Gaza strip, from Lebanon to Egypt.

#### 2. Water disputes of Nile river in Africa :

The Nile is called the gift of Egypt. Conflict is started among Egypt, Sudan, Ethiopia for Nile river after green revolution in Egypt. In 1902, Egypt has done use of water agreement with Sudan when British government ruled in Sudan country. After British government rule again the agreement had been done between these two countries in 1959. Egypt benefited greatly from this agreement. The dam was built on Nile river at Aswan in Egypt. Various part of Egypt is under irrigation. Ethiopia is also claiming on this water. Ethiopia trying to build dam project on Nile river from their country. Such efforts are underway in Sudan. If Sudan and Ethiopia will constructed dam project on Nile river then Aswan dam in Egypt will dry up.

#### 3. Water conflict of Africa continent :

Water conflicts have also arisen due to water distributing in the countries of Africa continent such as Mauritania, Senegal, Zimbabwe, Mozambique, Botswana etc.

#### 4. Water conflict of North America :

The Colorado river dispute has erupted in North America. The Colorado river is a boon in barren, Semi barren province such as Wyomin, Newada, New Mexico, Arizona, Texas and California. Water disputes are also raising in these states over the use of the equal amount of water.

## 5. Water conflicts in India :

Various major rivers in India are International and interstate. These rivers flow from one country to other country and from one state to other state. The demand for water is increasing in the different areas of nation. Because of this, water conflicts has started among states due to water distribution of river. Attempt to resolve water allocation issues with the help of central government is going on. Indian judiciary appointed independent arbitrator to solve the water conflicts such as Godavari water conflicts, Krishna water conflicts, Narmada water conflicts, Ravi and Beas river water conflict, Kaveri water conflict etc.

### Do you know ?

#### To peek into history - Water dispute on Rohini river

Since water is a limited resource, the struggle for its use is not new to the world. It has been continue since ancient times. The conflict along the Rohini River in northen India is familiar to all of us. The two towns on the banks of the river were Kapilvastu and Kolia. Both of them were using the water of this river for irrigation of their farms. But one year the rain subsided and this raised questions regarding water use. The quarrel escalated to the point of war. At that time, Shudhodhan was the king of the city Kapilvastu. In this context, Prince Gautama expressed his opinion that water is a gift of nature. This is due to the fluctuation of rainfall in nature. So war is not the right way to solve this problem. This issue should be resolved through discussion and harmony. History shows that in the end, without a war, the issues on both sides were resolved through discussion.

### • International collaborative agreement with the reference of water use and water management :

Collaborative agreement is done by India with neighbouring country for water. The next few of them are important.

#### 1. India - Bhutan co-operative agreement :

United council was established between the government of India and Bhutan in 1979 year. Its main purpose is to estimate the hydro-meteorological and flooding to rivers between two countries. In this regard 35 Hydro meteorological centres has been established in Bhutan. For this necessary numerical information is provide by the Indian government's central water board.

#### 2. India - Bangladesh collaborative agreement :

Joint river commission's function is started in two countries since 1972. The commission's work is run with the help of water resources ministry of two countries. A new study on water use in the Ganga's project plan was launched between the two countries from 12 December 1996. Flood forecasting information of Ganga, Brahmaputra, Barak is provided to Bangladesh by the Indian government.

#### 3. India-China collaborative agreement :

In 2002, the two countries signed on reconciliation statements. Hydrological information is provided between two countries especially water level of rainfall and adaptation water. China provides information about flood situation of Brahmaputra river to India. This enables India to take appropriate precautions to avoid loss caused by floods in Brahmaputra and their after effects.

#### 4. India-Nepal collaborative agreement :

This is the agreement regarding water resources development between two countries. Agreement of United development is accepted in 1996 about *Mahakali* river. Multipurpose project on *Mahakali* river at Pancheshwar known as '*Sharda*' project in India is the result of this.

## 5. Indus water agreement :

The Indus water agreement is signed in 1996 in between India and Pakistan.

### Collect information.

What is the proceedings of Indus water agreement at present ?

### • Government policy of Irrigation :

Government policy means that the government formulates profitable policies for the society in certain circumstances and issues order for their implementation through circulars. Water has been considered as national property in National water policy. The use of water is determined differently according to availability. To meet various useful demands water is a seasonal factor. Therefore, the water management code clarifies who can be involved in the use of water.

Sub-basin wise planning is done according to different rules as the status of each basin is different. While explaining the importance of government policies the policy of the government of Maharashtra is meant here. 39.13 lakh hectare irrigation capacity was created in state at the end of 2004. Out of this irrigation capacity of 16.97 lakh hectares i.e. about 43 % of the irrigated capacity was directly irrigated. Over the last seven years, the actual irrigated area has been around 43 % to 53 %. There is a big difference between the irrigated area and the actual use of area.

### Collect information.

Collect information of Irrigation capacity which occurred in Maharashtra state until year, 2020.

Government policy is of paramount importance in reducing unauthorized use of water, increasing irrigation revenue, and implementing proper management of the irrigation sector.

Government policies include the following topics of the Department of Irrigation.

1. Available water and its equal distribution
2. Use of water for irrigation
3. Financial aspects of water resources
4. Water management
5. Use of ground water
6. Geographical difficulties occurred in water resources
7. Crop structure
8. Water planning
9. Water tax
10. Organization for use of water and public participation

### • Water planning and Government Order :

Drought condition occur when there is insufficient rainfall in the state during monsoon season. Under the irrigation project, water storage in Ujani and Jayakwadi is less than expected. In such a situation, the government issues a circular to prioritize water allocation with a view of making changes in water allocation planning while implementing irrigation programme in year.

Under the act 1982, first priority was given to industrial, approved vertical food and fodder crops for drinking water.

As per the government resolution of the central Government sr. no. BKS/1083/2806(I)/(P)/1983 the prime minister has appealed for special emphasis on the production of cereals and crushed grains in the 20 point program announced. In this regard, various measures have been suggested for additional grain production, irrigation projects, notified rivers and streams. Also, priority has been given to irrigation land of cereals, pulses, oilseeds crops.

## • Some laws regarding Irrigation :

### 1. Laws regarding ground water

Groundwater use has increased exponentially since 1960 with the availability of electricity in rural areas. Groundwater use has increased at dangerous level in some catchment area. Therefore, intervention is necessary for the public interest as it is a threat to the public interest. National policy is laid down in the seventh paragraph of the National water policy of 1987 as control over such unrestricted use of ground water is necessary to establish environmental balance. Groundwater use should never exceed the possibility of recharge. Central government had sent a specimen bill to all state government in 1971. Again, similar type of bill was sent in 1992. For equitable distribution of groundwater, the right to groundwater must be separated from rights on land. The Government of Maharashtra has passed regulation for ground water in 1993 Maharashtra Ground Water - (Regulation for Drinking water purposes). However, the purpose of this resolution was limited to the protection of public sources of drinking water. In this, the Maharashtra water and Irrigation commission has said that it will be easier for water use organizations to implement effective control over canal water along with canal water management and will be used for pollution control.

### Water pollution (control and elimination) act 1974 :

In water pollution (control and elimination) Act 1974, central government especially has been amendment 252 article of Indian constitution in water pollution. The definition of water pollution in the section 2(3) of the law includes the chemical, physical and biological aspects of pollution, including human health as well as the health of plants, animals and aquatic animals. Central government has appointed **Tiwari committee** for review of implementation of versatile law. The report of the Tiwari committee pointed out the shortcomings and clarified the need

for greater publicity of the work of pollution control and eradication. This law was passed as per declaration of United Nations conference of Stockholm in 1986.

The department of water resources (previous irrigation department) has a glorious history of 150 years. Maharashtra state established in 1960 after division of previous Mumbai state into Maharashtra and Gujrat. In 1960 the public works department divided into, irrigation department and building and road department. From 26th October 2004 irrigation department was renamed as water resources department. Before the establishment of the state of Maharashtra, there were three different irrigation acts existed for Mumbai, Pune and Nashik department. Its applicable for 'Mumbai Irrigation Law' 1979 for west Maharashtra, 'Central Provision Act 1931' for Vidharbha, 'Hyderabad Irrigation Law 1848' for Marathwada region. Irrigation development gained momentum after state restructuring. But due to different laws in different regions there were difficulties in implementing water related schemes. Irrigation act created on dated 5th August 1976 in Maharashtra.

### 2. Legislation of valley wise corporation in Maharashtra :

Maharashtra Government has established five development board for completion of irrigation project. In this 'Krishna valley development board, Vidharbha irrigation development board, Tapi irrigation development board, Marathwada irrigation development board, Konkan irrigation development board are involved. In the early days after the establishment, these corporations were allowed to raise funds from the open market. Consolidated funds are raised from Maharashtra irrigation finance board for all corporation recently. Projects which do not come under the corporation come under the water resources department. The Government has taken concrete steps to strengthen the irrigation capacity of the state by restructuring all the existing irrigation

development corporation into the river development agency making changes in the planning and management of river basins. Geographically the state was divided into five river basins. In this, Krishna, Godawari, Tapi, Narmada and rivers from Kokan area west channel are involved. These five river basins have been further subdivided into 25 sub-basins for proper planning.

In three years of 1996 to 1998 approved basins wise 5 corporation 5 laws in Maharashtra corporation. There are 71 articles of laws which have same structure and function of corporation. However, on some important issues, the difference can be stated as follows. For example, Godavari water crisis is mentioned in Vidharbha corporation laws, but it's not mentioned in Godavari corporation. All areas of west Maharashtra and Krishna basins of Marathwada have been announced as work field. The Vidarbha and Konkan corporation has been given only certain projects without giving all the areas in that division. Dhule and Jalgaon districts part of Tapi basin is given to Tapi irrigation development corporation. All areas of Godavari basin Nashik and Nagar of Marathwada is given to Godavari corporation. Therefore, Soygaon Taluka and other talukas of Aurangabad district are involved in Tapi basins. It is not in the territory of any corporation.

In order to make the role of the government more tangible by involvement of the farmers in irrigation management to operate and manage the irrigation project by the people after the completion of the project is the basic definition of democracy. Following the same principle, law was enacted which gave equal justice to all the beneficiaries and gave the right to the weaker farmers to look after the irrigation development of Maharashtra and it means "Maharashtra farmers irrigation management act 2005". Maharashtra Government has passed an act for water use institutions. Therefore, water will not be provided individually for farmers by water resources department, water will be provided to

only water use institutes in cube measurement method and the government will be remain only the mediator between water use institutes and farmers.

### Collect information and discuss.

1. In which of the states water disputes are ongoing ?
2. What measure has the government taken on this water dispute ?

The government has facilitated this by selfing up water use institutes and transferring them to farmers for in irrigation management. It is big achievement of water resources management.

### Irrigation commission :

Maharashtra government has established second irrigation commission in December 1995 under the presidency of Dr. Madhavrao Chitale. After study, this commission pesented report to Maharashtra government in 1999. This commission has suggested 329 recommendations. It contains the following recommendations regarding drinking water.

1. Sub-basins that are likely to use more water than available. When planning such sub-basins drinking water provisions should be considered first and then irrigation water should be planned.
2. When the planning of drinking water in rural areas then pay attention towards necessity of livestock and management.
3. The *taluka panchayat samiti* should be entrusted with the responsibility of determining the exact source of drinking water and how to regulate it by considering all the water available to village.
4. The economic future of rural water supply schemes should be linked to the system of production, employment and sustainable income in rural life.
5. Village development program should be undertaken as an important component of rural water supply from peoples awareness, public participation and '*Rozgar Hami Yojnd*'.

6. Reduce the difference between urban and rural water provider.
7. More encouragement is needed to these activities of storage of water from raining and annually use of water.
8. To prevent pollution caused by sewage discharged into the river without any procedure, river wise awareness organizations should be formed immediately.
9. Social organization should take initiative to motivate women's organization in this regard by establishing women's organizations in rural areas and hand over to tap water planning.
10. In view of water scarcity plan to treat wastewater and make it available for reirrigation should be implemented to co-ordination with Maharashtra Jeevan Pradhikaran, Maharashtra Pollution control board and Irrigation department.

• **Water policy of Maharashtra :**

Central Government has announced modified water policy in 2002 and the states have been given guidelines for independent water policies. A separate water policy has been prepared and declared on dated 30th July 2003 for the state as per the recommendation of the second irrigation commission stating that the water policy should be conducive to geographical conditions of the state.

Maharashtra Government has adopted water policy from 2003. Water policy has been adopted for the management of river. This policy prioritize the rehabilitation of projects victims and providing benefits to them. Water policy is the best example of visionary and comprehensive of Maharashtra state. Intensive competition is being created among water consumer from different divisions due to growing population and water scarcity. In August 2005, Government established Maharashtra water resource of the regulatory authority in our country. This is the first such regulatory authority in the country. The organization is committed to

manage the available water resources in the state in an equitable manner, with equal distribution and assured management of irrigation. The state Government has taken steps to legislate, irrigation project of water account static making of project. Since 1999 the state Government has been publishing annual statistical report on irrigation projects. Maharashtra has become the first state after Australia to publish regular water audit report of projects.

**Objectives of water policy :**

1. Basin and sub-basin wise planning and management for integrated multipurpose development of available water resources for being divided into five main river basins.
2. Decentralization of management of water resources in minor irrigation projects and watersheds as well as water resources to local level. Irrigation projects with an irrigation capacity of more than 101 to 250 hectares have been transferred to the local water conservation department for development of the catchment area.
3. Establishment of water resources development corporation for proper utilization of river basin wise water resources as well as for overall development. The working procedure of this corporation is as following.
  1. To determine the responsibilities and rights of river basin organizations.
  2. Planning, development and management of water resources and watersheds.
  3. Determining criteria for water distribution in times of drought and water scarcity.
  4. Water storage and water distribution creates basic facilities. Therefore avoid extravagance of water and it will be used properly.
  5. To increase the participation of all types of irrigated integrated river development plans, increase the participation of people's representatives and collective opinion change management at the local level.



6. Quality management of water and long term maintenance of water system by implementing various schemes were included.

### **Maharashtra water resources regulatory authority act 2005.**

Maharashtra water resources regulatory authority Act 2005 appropriation of water resources in state, efficient of water resources, equitable and sustainable management, distribution, use etc. Provision have been made in this regard. There are 7 chapter in this Act and special provisions have been made for elimination of backlog as per the directions of the Governor. Regarding the backlog, the water resources, authority should be responsible for the backward districts and divisions in the irrigation system of the state. Survey of projects in the backlog affected areas, planning and construction of new projects on time to eliminate irrigation backlog this provision have been made. Maharashtra water resources regulatory authority was established in August 2005, while implementing Maharashtra water resources regulatory authority Act 2005.

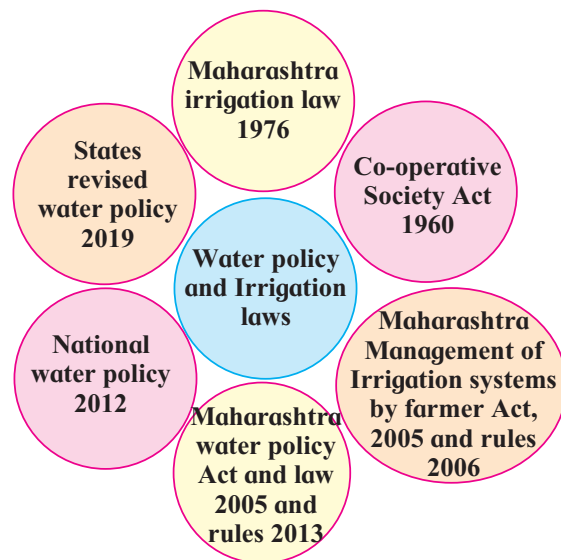

### **Exercise**

1. Write information of International cooperation agreement between India and Bangladesh.
2. Which topics are covered in government policy of irrigation ?
3. Write objectives of water planning of Maharashtra.
4. What are the objectives or policies of the Irrigation department ?
5. Compliance with water laws and regulations is important for every nation. Write your opinion on this.

## Unit 4. : Water Quality

### Chapter 1: Water Purification and Sewage (Wastewater) Management

#### Can you recall?

1. What are the simple and easy methods of water purification?
2. How is water purification process done for big cities / villages?
3. What is the exact difference between water purification and wastewater management?

#### • Turbidity of water

When water flows through a river, it contains soil as well as other soluble substances. Particles of such substances are in suspended state in water (In soluble as well as partially dissolved states). Therefore, the cleanliness, clarity, transparency i.e. quality of water is reduced. This is called 'Turbidity of water'.



*Flowing river water*

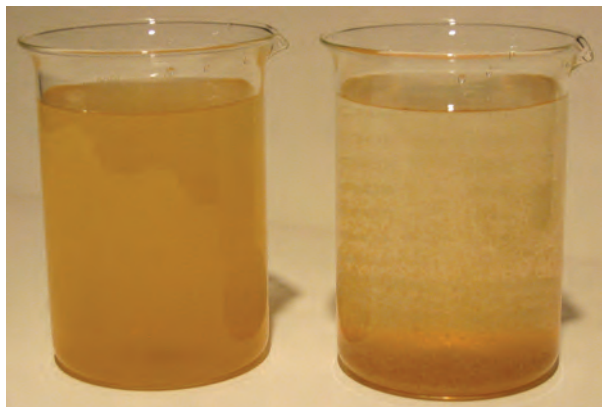

*Some samples of turbid water in the river*

It is misconception that turbid rainwater is waste. But after keeping this water stagnant for some time, its turbidity decreases or by applying the right amount of alum in the water reduces the turbidity of the water. Therefore don't throw away the turbid water. The 'Secchi's disc' experiment is used to measure the turbidity of water. A circular disc is used in this experiment. As shown in the figure, Secchi's disc is painted in white and black colour.

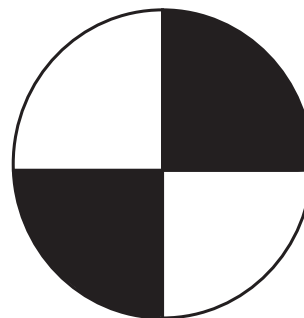

*Secchi's Disc*

#### Stages of the experiment

1. First go to the middle of a lake or river basin in a boat.
2. Secchi's disc is tied to a rope and dropped into the water.
3. Slowly lower down the Secchi disc until the white and black parts disappear. Then keep the rope stable.
4. When white and black parts disappear then prick a pin to the rope on the water surface. It is 'A'.
5. Now the rope is slowly pulled up. Pulling is stopped as soon as the white part of the disc appears and prick a pin to the rope on the water surface. It is 'B'.

6. Measure the distance between 'A' and 'B' using a meter bar.
7. The average length is measured using the following equation.

$$\text{Average length} = \frac{A+B}{2}$$

**Always remember.**

Turbidity of water is measured with the help of Nephelometer. The unit of turbidity of water is NTU. NTU means Nephelometric Turbidity Units.

Water turbidity level is measured by this method.

**• Different stages of water purification**

1. Pumping of water from a water source
2. Air mixing in water
3. Coagulation
4. Flocculation
5. Sedimentation
6. Sandstone water filtration
7. Disease Disinfection

**1. Pumping of water from a water source**

Water is blocked in certain areas of the river through dams. Big water pumps for pumping water are installed there. The water is pumped out and brought to the water purification plant through a pipeline. Wire mesh is installed to prevent fishes and small plants from coming out of the tap while pumping. If the distance between the water pumping site and the purification plant is large, the water pumping center is constructed in stages. In this way the water coming from the pumping center comes to the water purification center.

**2. Air mixing in water**



*Air mixing tank*

River water may have a specific odour. This is because it contains unwanted gases or substances. Air is added to the water to remove it all. The principle of gravity is used to mix air in water.

In this method water is released from a height through a large pipe. When water comes down, it achieves the thinnest layer and oxygen mixes in the water. For this a large pipe is erected at a certain height. It has circular steps built around it. When water falls through a pipe, then it falls from the steps, forming the thinnest layer and mixing oxygen in the water. Also at this time 0.2 to 0.5 ppm chlorine is mixed in the water. This is called 'Pre-chlorination'.

**3. Coagulation**

The materials used to settle down the suspended coagulate particles from water at the bottom are called coagulant. Alum is mainly used as a coagulant. Also ferric chloride, ferrous chlorite, ferrous sulphate are used to some extent. Poly aluminium is mixed with water. Mixers are used to mix coagulant in water in equal proportions. These mixers have small blades. With a specific chemical process coagulant and coagulative substances from water come together. Such water is sent to the collection tank.

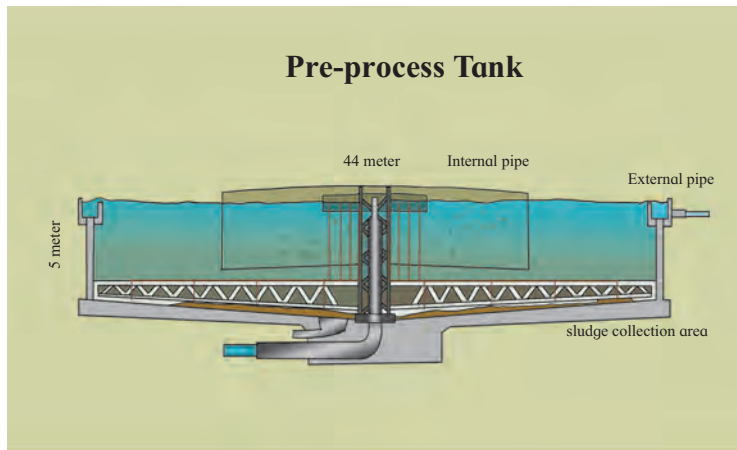

*Sedimentation Tank*

#### 4. Flocculation –

Flocculation is done in a large tank. The tank used for this is called Flocculation tank. Low speed rotating blades are used in Flocculation tank. Due to this rotating blades the fine particles come together and gradually become heavier. The water is kept in this tank for thirty minutes and that water goes to the sedimentation tank.

#### 5. Sedimentation –

In this process the water is kept still stable for some time. The insoluble substances in the water settle to the bottom. This process is called sedimentation. With the help of this process the turbidity of the water reduces. In the process of flocculation suspended particles in water become heavy. Such water is brought in a large tank to stabilize it. This tank is called 'Sedimentation tank'. In this tank water enters from upward direction. This causes clean water at the top and sludge to settle at the bottom.

#### 6. Filtration-

Fine sand is used to filter the water. Water is allowed to pass through a layer of sand with a thickness of 90 cm. Sometimes there are three layers of sand, thick, medium and fine, and a layer of ballast of 10 centimeters thick as well.

In this process, the sedimentary water is allowed to pass through a layer of fine sand, so that very fine coagulate particles in the water as well as germs get trapped in filter.

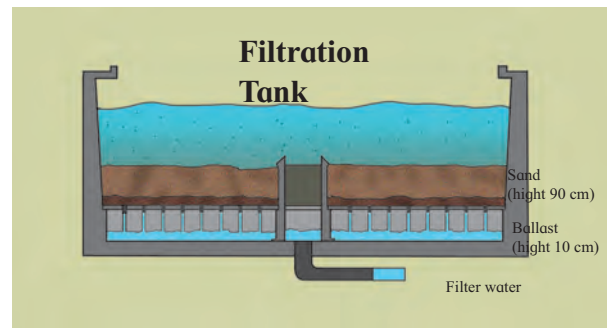

**Filtration Tank**

After filtering water through this layer of sand, the turbidity of water decreases to less than 0.4 NTU. The sand and ballast in filter is frequently washed with a mixture of air and water.



*Filtration*

#### 7. Disinfection

Although the water from the filtration process is clean but it is not sterile. It is necessary to destroy the germs in it. Gas is especially used to kill germs. For example Chlorine, Ozone, Bromine. It is convenient and safe to mix mainly chlorine gas in water. This

gas is dissolved in water in liquid or gaseous form. When chlorine gas is mixed with water to form hypochlorous acid, it kills germs in the water. Too much chlorine can kill aquatic viruses as well as micro-organisms. Bromine and iodine are also used for this. Water is also disinfected using ozone gas, but Ozone gas has to be produced artificially and is expensive. Ozone gas mixes with water as little as 0.8 to 1.6 PPM. Ozone gas removes colour and odour of water.

### 8. Storage of water in tanks and distribution (Distribution of water)

Purified and sterilized water is stored in a large tank. At high pressure this water is discharged into a high water supply tank. From those tanks this water is distributed to different parts of the city.

#### • Equipment used for domestic water purification

The water supplied from the public water supply system is pure but everyone feels that drinking water should be pure as there is a lot of awareness about water pollution. Today

various types of water purification equipments are available in the market. They are widely used for domestic purposes.

Let us take a brief look at the functioning of available water purification equipment.

#### 1. The use of ultraviolet radiation

Water is filtered in three stages in a water purifier where UV rays used. In the first stage, activated carbon is used to remove water dust, fine sand or waste material. Nano silver coated carbon filters are used to remove unwanted taste and odour from water. In the last stage, germs and viruses in the water are killed using 11 watt ultraviolet lamps.

This process kills only bacteria and viruses in the water. There is no effect on the basic minerals in the water. In this method, the germs killed in the water are not removed from the water. They remain in the water, that germs are more likely to become reactivated. The efficiency of this device decreases if the water is very turbid. Also this device cannot activate without electricity.

#### Observe.

Observe the equipment shown in the picture below. You can see these devices in different places. Collect the information, how to purify water with the help of these devices and give presentation in your class on how is the water purification process carried out ?



## 2. Ion exchange

This method is used, for removing the high contents of salts from water. Eg. Water containing high levels of magnesium and calcium carbonate and bicarbonate. From this water magnesium and calcium salts are replaced by sodium salts and reduces the water hardness. It also destroys germs and viruses in the water. Water purification equipment based on this principle is used in places where the salinity of the water is high.

## 3. Use of ozone gas

Ozone is an excellent disinfectant and oxidizer. Ozone removes unwanted colour, taste and odour from water. Ozone removes manganese, sulphide and nitrate ions from the water. Ozone destroys sublimatory carbon compounds.

## 4. Filter suitable for taps

Iodine is used in the tap filter. Resin technology is used in this process. When water flows through the resin, iodine is added in water. Iodine kills harmful germs and viruses in the water.

## 5. Life straw

It has a plastic straw with ion exchange resin in it. Water enters through one side of

this straw. In order to get the water out of the tap on the other side, it has to be pulled through the mouth. In this process, as water enters through the resin, the pathogens in the water become trapped in the resin and also the turbidity of the water decreases. Water can also be absorbed by placing this device in a water container. This device is easy to carry and is useful during travel.

## 6. Candle filter

If the water coming into the house is less contaminated and also contains the right amount of minerals, then a candle filter is used. It consists of pots placed one above other. Filter rods are placed at the bottom of the upper pot. The water in the upper pot is filtered through rods. At that time the turbidity of the water is removed and the amount of chlorine is reduced. However, these rods have to be cleaned frequently to remove the sticky soil particles on the outer surface of the rods. They are also immersed in boiling water for some time to clear the pores and improves water filtration process.

Water is purified by using triad of filtration, settlement and boiling. Therefore this system is being used in every house.

### Try this.

Observe the water purification filter in the house. On the basis of filter, explain how water purification process is done? Which precaution will you take while using a filter?

### Collect information.

Collect information about water purification and water supply by visiting the organization that supplies water to the city or village.

## Exercise

1. Where do you get drinking water from? How ?
2. What is the difference between drinking water and river water?
3. Why is it said that untreated river water is not suitable for drinking?
4. Which are the water purifier tools in your house? Describe them .
5. What are the important stages implemented in water purification?
6. What are the advantages and disadvantages of purifying water with UV rays?

### Avoid this : Wastage of water

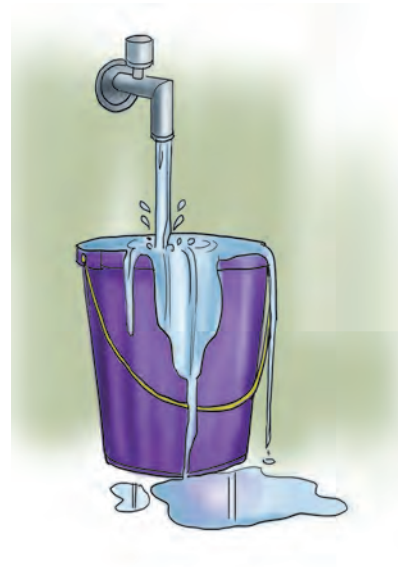

### Do this : Water saving

## Unit 4. : Water Quality

### Chapter 2: Environmental Life Style

#### Can you recall.

1. What is water quality?
2. How is water quality measured?
3. How is water quality maintained?

#### • Concept of Earth Overshoot day

Every year nature adds to our resources in various ways and man uses those resources to deplete them. Over the years, our usage of resources was less than the natural resources being added. Therefore there were abundant natural resources. This went on for many years. Then one day, we reached when we started using all that, nature has added. That is, there was neither growth nor reduction. But gradually situation changed and we started using more than what nature created throughout the year. Our balance in the bank of nature began to deplete. This is called 'Earth Overshoot Day'.

#### Let's prepare a one year audit.

We finished everything before December which is created by nature from January to December. Now this overshoot day is shifting down from December to November, November to October, October to September, that's how we're moving. Do you know what is the Overshoot Day for 2019?

That is 27 July 2019. What a horrible concept is this!

This means that what nature created in 2019, we finished it on 27 July 2019 only. Man is literally plundering nature, snatching it. So did you realize our journey?

The question does not end here. While this is going on, humans have also started destroying the environment. Today land, forests, minerals, water and even air are not

safe. We are destroying biodiversity. If this continues, then we have to say that we are inviting our destruction. We have completely changed our lifestyle. When will we realize that it is harming the environment? Now let us understand what we do from waking up in the morning upto sleeping at night and how we are destroying the environment while doing all this.

#### • Incidents that pollute the environment means mainly pollute water

##### 1. Washing mouth in morning

The paste we use when brushing our teeth contains 2 to 5 grams of chemicals. It contains phosphate, carbonate, fragrance and multi-colour chemicals. When we wash our mouth, those chemicals are dissolved in the water and we may not even realize that we are causing the water quality to deplete. As an environmentalist, use neem or acacia sticks, charcoal powder, salt, ash, won't it stop destruction? We are happy because we feel refreshed, by using these chemicals but don't even think about what will happens to the environment.

##### 2. Shaving in the morning

Did you know that shaving and soap foam don't have much connection between them? While shaving, wet the face with hot water and wait a while to shave, then also it will give clean and smooth shave. We are not aware about that. But we use soap or foam. Shaving cream or soap contains various chemicals. While doing this we are consuming up to 2 to 5 grams of sulphate, carbonate, stearic acid, ethanol, amine, fragrance chemicals and polluting the water. This must be stopped if the environment is to be protected.



### 3. To take a bath

Two points should be considered while bathing. How much water is used for bathing? How much soap is used while bathing? The purpose of bathing is to keep the body clean. The bath can be done in a twenty litre bucket, can be done under a shower using 50 to 100 litres of water or can be done in a tub using 300 - 400 litres of water. Morally do you agree to use too much water for bathing. In fact many people are not getting enough water? We need to be aware that while bathing we are converting good water into waste water. In daily life, use of soap and shampoo has become a routine. While making soap, we use about 6 to 10 grams of edible oils, aromatic/fragrant chemicals, dye sulphates, carbonates, sodium, detergents. The body can also be cleaned by wiping the limbs with a simple wet cloth. Instead of soap, we should use *Ritha*, Cosmetics/*Utane*, *Shikakai*. For kids, we can use milk cream or gram flour.

### 4. Washing clothes

Different types of soap are used for washing clothes. These various soaps contain eight to ten grams of chemicals like phosphate. No one talks about the fact that it causes environmental degradation. We are not even not aware that certain chemicals shorten the life of washed clothes. The use of washing machines has become common, but we do not keep account of the amount of water we need. We don't realize that starting the machine even when the load is not full is a waste of water. How many people know that *Ritha* makes clothes clean? Put eight to ten pieces of *Ritha* in a cloth bag and while washing clothes keep this ritha bag in the washing machine. The clothes will look clean. That bag can be reused next day. Since *Ritha* is environmental friendly. It also avoids environmental degradation. *Shikakai*, vinegar can be used in washing machines for washing clothes.

### 5. Washing utensils

Earlier in Rajasthan, utensils were washed by fine sand. Water was not used for that. But now in the new life style we invent dish washers for washing utensils. Not only this, we also started using various chemicals to clean it. This releases about 20 grams of chemicals into the water. Substances like phosphates, carbonates, silica are used for this. Coconut shells, cow dung ash, charcoal ash or even clay can be used to clean utensils.

### 6. Toilet cleaning

For this bleaching powder, acid, sulphate, chloride, phenols are widely used. It may clean the toilets, but do we take into account the environmental damage. Instead of this, make a paste by mixing vinegar and baking powder and use it to clean toilets without any damage. Both of these things are environmental friendly. The same solution can be used to wipe the floor.

### 7. Use of cosmetics

Various types of oils, face powders, nail paints, perfumes, kumkum, scented sprays, lipsticks are used as cosmetics. It contains about 18 different types of harmful chemicals. Their use causes water pollution. Therefore, five to ten grams of chemicals are added to the water every day. To prevent this, substances like *mehendi*, *vala*, ayurvedic oil, curd, turmeric, *dal* flour, papaya, cucumber, banana, honey, milk cream are helpful.

### 8. Rituals and *Nirmalya*

For *Pooja*/Worship and other religious rituals incense, flowers and other *pooja* materials are used. On the second day of worship, it become *nirmalya*. It is released into the water. This mainly leads to water pollution.

Large water-insoluble idols of gods and goddesses, the artificial colours used to make those idols, and other substances (plaster of Paris) are mixed with water at the time of immersion. At the same time, hundreds of tons

of *Nirmalya* and other hazardous substances generated from religious activities are immersed in water. Municipalities and related organizations have to work hard for days to clean them up. Festivals and celebrations should be celebrated but it is important to take care that the environment is not harmed while celebrating them.

Now let us take an example and check how this affects on water. For this we will take the example of Pune city. The population of Pune city is around 50 lakhs. Every day each person mixes about 50 grams of chemicals in water. This means that every day we mix 50 lakh times 50 grams means 2,50,000 kilo of chemicals in water. If we calculate for the year, we will realize how big a mistake we are making. No technology is effective to decompose these chemicals. If we do not want this to happen, we need to change our lifestyle. For that here are some solutions as follow –

- **What's the problem of changing our lifestyle ?**

1. **Separate wet and dry waste**

Is there a connection between waste and the water? Yes. When water falls on open waste, it rots, decompose, spreads its stench, increases the germs and diseases. This leads to many health problems. Most of the time, people throw all the garbage in an old well in the neighbourhood to block it. Rainwater falls on it and it decomposes. Often this waste is dumped in river, streams and it flows and accumulates in lakes. This degrades the quality of the lake water. Contaminated water seeps into the soil and groundwater begins to become polluted. Contaminated surface water can be easily purified but contaminated groundwater is extremely difficult to purify.

Wouldn't you be surprised if garbage was called wealth?

There are some countries in the world like Sweden that buy garbage/waste from other countries. In our country, however, garbage/waste has become a problem. If this problem

### Do you know ?

#### Proper recycling of Garbage

Garbage problem can be solved in three ways. Prevent garbage/waste generation, Proper disposal of generated garbage/ waste, Garbage /Waste recycling.



### Try this :

#### Use of Garbage for soil fertility.

Plant dry leaves, wet waste can be composted by decomposing it in the rainy season or in moisture. National Centre for organic farming has developed waste decomposer. Their price is just 20Rs. It is delivered by post. With the help of it, good manure is produced in 40 days.

Biochar of plant dry leaves, grass can be done in winter or summer. The pyrolysis produces biocompatibility in low air by a controlled combustion method. Biochar can be used for increasing soil fertility and for various other purposes.

Waste decomposer and Biochar are two multipurpose substances.

### Internet my friend

Get information about organic farming and make a report of it.

can be solved, it will be a big preventive measure against water pollution.

## 2. Sewage treatment and reuse of that water

Today water is viewed differently. Rainwater is known as green water. The water in the river, lake, well is called as blue water. The water that flows after bathing is called grey water and the water that comes out of the toilet is called black water. If we purify this grey water and black water, it is possible to reuse that water.

The amount of wastewater of generated after use is more than 75% to 80% the amount of used water. In that case, if we purify this 80% water, then we will have that much water available. We can succeed in increasing 80% of the water supply. In many countries around the world, wastewater is treated and reused in this way. In India, saving water in this way needs to be seriously considered.

**Example 1 :** A housing society has a hundred flats. An average of five people live in each flat. Each person uses twenty litres of water for bathing. This means that the total water requirement for this work will be  $(100 \times 5 \times 20) = 10,000$  litres. Build a tank on the ground floor to collect the bathroom water of all these flats. Similarly, build a tank on the terrace. Fetch the water from lower tank to upper tank daily with the help of water pump. Make design in such a way that, this water will be available for cleaning all the toilets. That means the society will save 10,000 litres of water per day. To this, if we multiply by 365 days then need of 36,50,000 litres of water per year will be reduced.

**Example 2 :** A factory needs water for production process, canteen, toilets and garden. Most of the water required for production is evaporated. The rest of the water, canteen sewage and toilet sewage can be collected and purified. It can used for gardening. This can lead to huge water savings.

**Example 3 :** 500 students live in a college hostel. These students need 10,000 litres of water per day for bathing. All the water coming out of the bathroom is collected and stored in a tank. If this water is released to the garden through a pipe from there, then many plants in the garden will be able to get water through out the year. If orchards are planted, the organization will get a lot of income from it.

**Example 4 :** The sugar factory needs a lot of water. In the factory, the juice is extracted from the cane for crushing. This juice contain 90% of water. This juice is heated to make the sugar. During this process, the water evaporates. If we cool these vapours then we

### Do you know?

The ashram school at Jakatwadi near Satara has 320 residential students. The water coming out of the toilet is filtered and purified and used again for orchards, backyards and sanitation.



can get water which will complete the need of sugar factory. This experiment has been done at 'Natural Sugar', a sugar factory in Kalamb taluka of Osmanabad district. Today the water requirement of this sugar factory is zero.

**Example 5 :** In a city there are 4 to 5 wastewater treatment plants. It takes 15 litres of water every time to flush all the toilet waste

to this project. If one sewage treatment plant is set up in each colony then it will take very little water to get sewage there. Doing so will save millions of litres of water per day.

Water is mainly used for domestic, agricultural and industrial purposes. Let us now see with an example that how it can be reused for each of these tasks.

### **Always remember.**

1. We need to consider whether any technique we use does not endanger our resources.
2. There is a need to use environmental friendly techniques.
3. Our country needs to find the new techniques to save water.

### **Collect information.**

Find out, if there is an innovative project for water conservation being implemented in your area, and tell everyone in the class.

## **Focus on development and use of new techniques**

### **1. The municipality can make money by selling wastewater.**

Koradi Super Thermal Power Station is located near Nagpur city for power generation. Here it takes a lot of water to keep the machines cool. For that there is no need of pure water. Recently, Nagpur Municipal Corporation has entered into an agreement to purify the sewage accumulated in the village and sell it to this power station. Nagpur Municipal Corporation gets compensation of around Rs 100 crore for this. As a result, there is no need to use pure river water for this purpose. This was a good reuse of water. The sewage water that used to be discharged into the river has now been stopped and this could have an impact on

improving the health of the people of Nagpur. Municipalities need funding for development. It may be available from this new source. Can't all the municipalities and corporations in the state and the country use the same project?

### **2. Experiments in Aurangabad's Waluj Industrial colonies/Estate**

Aurangabad has a large industrial colony/ Estate at Waluj. There are hundreds of factories here. In all these factories wastewater is formed. Maharashtra Industrial Development Corporation has come up with a new idea to dispose of this wastewater. All this wastewater is collected in one place in the colony. There the water is purified and that water is made available for use in all gardens in factory or for other minor work. Not all factories can afford to set up wastewater treatment plants. This is a very good facility for them. Many cities in Maharashtra have industrial colonies/estates. If such projects are set up in every colony, the wastewater can be recycled better.

### **• Sewage management**

Rainwater is available for maximum of 100 days. Once this water supply is exhausted then we have two options. The first is to use the stored rainwater and the second is to reuse once used water. Water storage is facing limitation day by day because there is no space left to build the dam. Considering Maharashtra, underground rock structures are not suitable for water storage. So we have to use stored water as long as it can be used. But 'what is next' is the real question. In such a situation we have to learn proper wastewater management. It is important to think about how many times we can use the same water again and again. As often as possible, the more time we have, the more we will succeed in preventing water scarcity.

### **Where does the sewage come from?**

It is also important to look at from where the wastewater is generated. It can be domestic

or generated from factory. If it is made from domestic origin, the pollutants in it are very mild. The domestic sewage comes out from bathroom, kitchen sinks, toilets, wash basin. Drainage dirt, rotten food, vegetables, soap foam has negligible contents of chemicals or metal. If the sewage is coming out from the factory, then it may have various chemicals, metal particles, generated by lathes, grinding and cutting machines, machine oils, lubricants, used during manufacturing process. It has more contents of chemical. Since the components of the above two sewages are different. The treatment processes required for them is different.



*Sewage*

- 1. For domestic sewage:** Sewage treatment plant (STP)
- 2. For factory sewage :** Effluent treatment plant (ETP)
- 3. Sewage generated from agriculture:** This wastewater/sewage contains traces of chemical fertilizers and pesticides. Therefore, it is advised to use chemical fertilizers and pesticides to use in a limited manner.

#### How does water become wastewater?

When we use water, the soluble ingredients are mixed in it. If we can separate them out, then can reuse that water again. If we can remove there soluble contents fully. Then it is useful for drinking. But even if we are able to

remove 80 % of the soluble contents then also we can reuse this water for various purpose. Country like Singapore has adopted these techniques and practices. It is easy to separate the ingredients which can not be dissolved. For this, various sieves are used to separate the microscopic contents from the water. But it is difficult to separate the soluble ingredients from the water.

#### How is wastewater treated?

##### 1. To run a wastewater treatment plant.

In this method the purification process is carried out in several stages. Purified water can be made available for secondary use. It costs lot of capital to set up such a project. Not only that, but it also costs a lot of energy and it also requires trained manpower to run the project. Due to inability to spend so much, wastewater collected, it is discharged into rivers and streams without any treatment and that raises public health issues at many places.

##### 2. To run environmental friendly processing projects

In this method wastewater is treated using specific species of trees and properly selected bacterial cultures. There is an important problem with this method. It takes a little more space. This method is very affordable in terms of cost. No chemicals are used in this process.

##### • Centralization and decentralization of the purification system

The important issue is whether the city's wastewater should be collected and treated or whether there should be a decentralized system of treatment. A city usually has seven to eight sewage treatment plants. This means that the wastewater travels several kilometers and is then treated. This leads to unnecessary misuse of water. About 10 to 15 litres of water is wasted to flush in the toilet.

The real question is whether we can use so much water for this work today when there is water scarcity. If the city has a large number

## Water management in Singapore

Singapore was relied heavily on Malaysia for water. A few years ago, Malaysia proposed to change the terms of the water agreement and demanded increased water rates. These rates were unilaterally increased and were not acceptable to Singapore. Therefore, the Singapore government began to consider alternative routes. Different ways came out of it. Measures such as use of rainwater, efforts to raise groundwater levels, reuse of wastewater after treatment, treat seawater and convert it into fresh water. These are the definite effort to reduce dependencies on other countries for water. The efforts made for the success of water management by not only stopping the management of water resources, but also by making laws and enforcing them strictly. Today we are seeing the results of it.

**1. Planning of rain water :** Rainwater is stored and used by creating various artificial reservoirs. At the same time, 1/3 of the total surface area of the country is reserved as protected watershed land use, restriction have been imposed on the area so that rain water collected from that once can be used for drinking water. Each building is given the target to collect the water. If it fails to collect the water, then there are legal penalties. Approximately 20% of the water requirement is fulfilled from it.

### **2. Import of water from Malaysia :**

Approximately 50% of the required water was being imported from Malaysia. Efforts were made to reduce this dependencies after the unilateral tariff hike. The Singapore government is also working to reduce imports from Malaysia.

**3. Drinking water from sewage:** Singapore does not have enough water available in the country. That country has to buy water from neighboring Malaysia. For this, a long-term agreement has been signed with that country. But Singapore has decided to be self-sufficient in water. For this, taking advantage of science, wastewater is purified so much that it can be used for drinking. They call this water as 'New Water'. For this, big factories have been set up in the country. About 35% of the country's total available water is obtained in this way. Initially the citizens opposed to drinking this water, but they were convinced that the water was completely purified, that time they accepted it. Today this water is widely used. Of course when the government campaigned extensively to use this water then the citizens were convinced of its purity. What is the problem of any municipality or corporation in our country to try such a modern experiment?

**4. Processed sea water:** Seawater is used for desalination by removing salts and making the water suitable for human consumption. For this purpose, similar projects have been set up in many places and about 10% of the daily use of water is obtained through these measures.

When managing water, we should not stop planning for water. Government has to strictly enforce the laws and implement to overcome the shortage of water.

of wastewater treatment plants, they can be located three to four kilometers from your home. Then it will not take much water. There is a lot of stress on the wastewater management centers that have been set up now a days. So often that the sewage water is discharged into the river without any treatment. Therefore, the purpose of their establishment has been destroyed. Going further, it can be said that why this system should not be in every colony or society? If this happens, huge water savings can be made. Which technique is better, what might be the answer to this question. The answer is that the technique is best that has been designed keeping in mind the issues in our country. The water crisis in our country is intensely threaten. So keeping that question in focus techniques should be planned.

### What do they do with the water when the purification process is complete?

How far has the purification process taken? Based on this, it can be decided what the water should be used for. The following are some options to be consider:

1. If it is 100% pure, it can also be used for drinking.
2. It can be used for indoor or city garden.
3. At bus stand or train station water can be used for washing buses or trains.
4. It can also be used for toilet cleaning.
5. If there is a power plant nearby, it can be used for cooling equipments.
6. If the purified water is released into the village river, it can be used for further agriculture.

**Let's develop personality through reading and listening :** Water conservation can be done effectively by reading and listening to more information on water issues as well as water management. Dr. Dattaraya Deshkar has taken the initiative and started 'Jalagamvad' Magazine. Read 'Jalagamvad' Magazine regularly. This magazine is available on the site. 'Jalagamvad' web radio is also available, which provides 24 hours awareness on water issues. Download this from the play store and listen.

### Exercise

1. What are the incidents and factors involved in polluting water in daily life?
2. What will you do to prevent water contamination? Make a list.
3. Make rules about the precautions to be taken by house members to maintain water quality.
4. Explain how water is wasted.
5. How can sugar mills fulfill their water needs?

## Unit 4. : Water Quality

### Chapter 3: Planning of Underground Saline Water

#### Can you recall?

1. How is the distribution of water on earth?
2. How is the distribution of groundwater?

#### Let's think.

Can saline water be made usable?

#### • Desalination of the saline water of the sea

We are all experiencing that the groundwater level in India is going down day by day. Water quality is also changing due to increase in pumping of groundwater. In addition, the water crisis is getting worse due to change in the monsoon period.

12 states and union territories of our country have long seashore. If the sea water is purified and desalinated at various places, the water crisis can be overcome to a great extent. Desalinating seawater is very expensive but with the advancement of technology, the cost has come down a lot. The water available due to the process of desalinating of seawater is suitable for drinking, agricultural and industrial use. Using seawater by desalinating it, is now becoming an option to address the world's water crisis.

55% of Israel's domestic water is currently sourced from saline water. In the countries like Australia, North Africa, Caribbean Islands, South Africa and the United States the projects for the desalination of the Sea Water are going on. There are other 150 countries where almost 17000 projects are already under execution for the desalination of Sea water. The World Desalination Organization claims that this desalination project is supplying 21 billion

galances of sweet water every day.

Desalination projects are executing in Tamil Nadu, Andhra Pradesh and Pondicherry in India. A similar project to supply 100 million liters of fresh water to the city of Chennai has been executed. According to Desalination Organization in India, there are over 1000 desalination projects in which their capacity of sweetening the water of 20 cubic meters to 10000 cubic meters everyday.

#### Collect information.

Collect information about the function and process of desalination of the saline water of the sea.

#### Is it financially affordable ?

The average cost of converting seawater into sweet water is only 10 paise per litre. This cost can be further reduced if unconventional energy sources are used. In the last few years due to public participation, the cost of desalination is decreasing. The 'Sorek Project' in Israel is the largest desalination project in the World. In this project, the cost of desalination of water is just 58 cents i.e. it takes approx. Rs. 40 to Rs.50 per 1000 litre to make the fresh water. The Ministry of Urban Development of the Government of India will build 100 smart cities in which it would be more appropriate to use sea water near the beach by desalinating it. Today, the cost of desalination is just 1/3 of the cost in the year 1990. Only the cost of desalination projects should be borne by the Central Government, State Governments, Local Self Government Institutions and Private NGOs. The projects based on pumping of ground water should not be encouraged in 'Sagarmala' projects implemented in coastal states.



• **Underground saline water**

Saline water may not be just in the ocean, it may be underground. It is saline. There are two main reasons for this. The first reason is that salt water from the sea and creeks seeps into the shoreline. This type is found in the *Konkan* belt of Maharashtra. Excessive pumping of fresh water from the land on the coast creates cavities there. The saline water of the sea began to percolate to fill it. Once this process is started, it becomes difficult to use the fresh salt water for drinking and farming. This is because of the large amount of pumping of water by humans.

This saline water and the fresh water do not get mixed. This is because the density of these two waters is different. They have different layers. The lower water is saline water and fresh water is found in the upper layers of groundwater due to recharge. Therefore, sweet water is pumped out first and then saline water is pumped out. In such situation, it is possible to estimate after how much pumping the saline water will appear.

The second reason for this is that the natural condition of that area. Naturally in some underground places, there are saline water reserves.

**Saline water belt in Maharashtra :**

There are two major Sedimentary regions in Maharashtra. The sedimentary region of Tapi river in Dhule, Jalgaon and Nandurbar District and other sedimentary region of

Purna river in Akola, Amravati and Buldhana District. The total area of this region is 6200 square kilometer. The fresh water is available in the belt having the length of 120 kilometer from Bavanbir to Chandur Bazaar with area of 1608 square kilometer in Buldhana District. But in the rest of the 4692 square kilometers there is a problem of saline water. The saline belt is about 10% of the entire Purna river basin. It is on both banks of the Purna river. Pedhi, Chandrabhaga, Shahanur, Wan, Katepurna, Nalganga, Dhyanaaganga, Morna and Mun are the major tributaries of Purna river. The groundwater in this saline water belt is so salty that in historical times salt was made from this water. Purna river originating in Betul district of Madhya Pradesh, flows from north to south in Maharashtra and flows from east to west from Amla village in Amravati district. The electrical conductivity of the groundwater in this saline belt of this valley is above 2000 micro ohms/cm. Due to the salinity of ground water, the villages in this belt have to be supplied drinking water through pipelines outside the saline belt. Due to various reasons, schemes there are difficulties in getting water from these expensive regional , so in summer, the situation is very bad. There are a total of 894 villages in the saline belt. The details are as follows.

This region is known as the saline belt in *Vidarbha*. This region is not small enough in size to be ignored, it is spread over about 4693

Sr. No.	District	Total included villages	Area of saline belt in hectares	Area of saline belt in sq. km.	Population
1.	Amravati	355	173817	1738.17	1137000
2.	Akola	373	193905	1939.05	503000
3.	Buldhana	166	101500	1015.00	350000
		<b>894</b>	<b>469222</b>	<b>4692.22</b>	<b>1990000</b>

*Details of saline water belt in Maharashtra*

square kilometers. The region is four times bigger than the size of Singapore country. The people of the region have been facing a saline water crisis from many years. The major problems facing by them can be mentioned as follows.

- This saline water is unsuitable for drinking. The taste of this water is so salty that it can not be hold in the mouth. The salts in it are harmful to health.
- The people have to bring drinking water from outside the saline belt by pipe line. This is very expensive.
- This water is not suitable for irrigation
- The use of this water for irrigation makes a difference in the physical and chemical properties of the soil. Therefore, even though the land is fertile, it cannot be harvested.
- Rainwater is consumed as much as can be produced. So there are a lot of limitations to the cropping pattern. Double farming season is not possible.
- Due to the persistent salt water crisis, a large number of people are migrating from this area.

#### **How the water in this belt became salty?**

Some experts studied why the water in this belt became so salty and given their opinion about it. According to them, about 1 lakh years ago, due to changes in the geological structure, the land in this belt was eroded by 300 to 500 meters. There the sea water penetrated in it and since there was no way to move, it settled down there. Later, soil and sand accumulated here. Alternate layers of yellow soil and sand formed and this salt water was trapped in this layer of soil and sand. Saline water is deeper at a distance of 20 to 30 meters from the surface of the soil. In the part of the saline belt of Amravati, Akola and Buldhana district , in some parts of the Purna river basin, up to 12 meters above the surface of the land,

impermeable yellow soil is there. Below there is a layer of sand of about 5 meters. Again yellow impermeable soil is there. This yellow soil does not allow water to go down. If this region is to be developed, the problem of saline water must be solved as soon as possible.

#### **What is a solution?**

According to experts, the problem of saline water can be solved as soon as possible by using the impermeable and mercury layers (apary and pary layer)found in the Purna river basin in Amravati, Akola and Buldhana districts in the saline water belt. This problem can be solved permanently without touching the rivers, if the flows of water and streams in this section are deepened up to 20 meters and widened up to 30 meters to a length of 1000 meters and a cement dam is constructed. After the monsoon, when the dam is full, 6 lakh cubic meters of fresh water will be available in it and excavated areas and this problem of saline water will be solved permanently. This stagnant fresh water will not mix with the saline water below, as there is again impermeable yellow soil just twenty meters on the ground. Even if mixed, this fresh water will float on salt water due to different densities. This fresh water will be available for drinking and agriculture. Therefore, more income can be obtained from agriculture. In this way the development of backward saline belt will give a boost to the dependent industries in this area and will reduce the migration from this area.

#### **Do you know?**

Innovative method of water conservation in coastal / saline belts: Reducing the increased salinity of the soil through green manure.

Find out more information about this innovative method from the internal.

### Do you know?

#### Innovative experiment of use of water in saline belt / Konkan belt: *Pagoli well*

Saline water is found in the sea and bay areas. Therefore, wells are not dug in this area. Shallow depth farm ponds are built. But, it cannot be used for drinking water. Therefore, *Pagoli well* is constructed for rain water harvesting. This is a kind of tank. After the initial rainy days, the roof water is stored in these tanks and is used for drinking during rest of the days.

These tanks are made of ferrocement. Jalvardhini institute has developed this technique. Ferrocement tanks have been constructed through public participation.

#### Experiment in Srilanka

Sri Lanka was hit by a tsunami in 2004. This caused the saline water of the sea to enter into the coastal villages. Sources of drinking water, land became saline. Crop growth affected. Attempts were made to improve land quality through various green manures. The best effect was the remnants of the tamarind leaf and nachani crop. The saline land was acid free. Adding acidic tamarind leaves made a good change. These two measures significantly improved soil fertility in four to six months.

### Exercise

1. Why is it said that saline sea water is also important?
2. How groundwater would have become saline in the saline water belt?
3. What efforts will have to be made to ensure that groundwater in the saline belt does not become saline?

Notes

A series of horizontal dotted lines for writing notes.

Notes

A series of horizontal dotted lines for writing notes.



# WATER SECURITY

STANDARD TEN

Workbook (Activity and Project Notebook)



MAHARASHTRA STATE BUREAU OF TEXTBOOK PRODUCTION  
AND CURRICULUM RESEARCH, PUNE.

जलसुरक्षा इयत्ता दहावी (इंग्रजी माध्यम)

₹ 82.00