



Promoting Private Sector  
Development in Agriculture

## Rocket brick stove

# Builder's Manual and User's Guide



**giz**



## Construction of the rocket brick stove

### Introduction to rocket stove technology

The rocket stove is a new improved firewood-efficient cooking stove for households. It is designed to reduce the firewood needed for cooking and minimise smoke in the kitchen. The rocket stove can be made out of fired clay bricks or good clay soil. In places where there is no proper clay for the construction of mud stoves, good red soil which is sticky can be used, although it comes with high maintenance.

For long-lasting quality and minimal maintenance, fired clay bricks, cement and lime are the best materials to use. They are available at comparatively low cost even in rural areas.

### Advantages of the rocket stove

- Highly efficient combustion (saves about 60% of firewood compared to open 3-stone fire), therefore a significant saving of firewood.
- Reduces smoke in the kitchen dramatically, due to proper combustion.
- Fast cooking — the temperature below the pot is about 600°C, compared to 300°C for a pot sitting on a 3-stone fire.
- Long lifespan of stove.
- Various pot sizes can be used.

The stove's main component is the **combustion chamber**. It also has insulation to maximise thermal efficiency, and a built-in brick skirt which increases heat transfer to the pot. The extra air inlet brings oxygen for the firewood to combust completely. Since the rocket principle reduces smoke dramatically, no extra chimney is necessary.

## The Rocket Principle

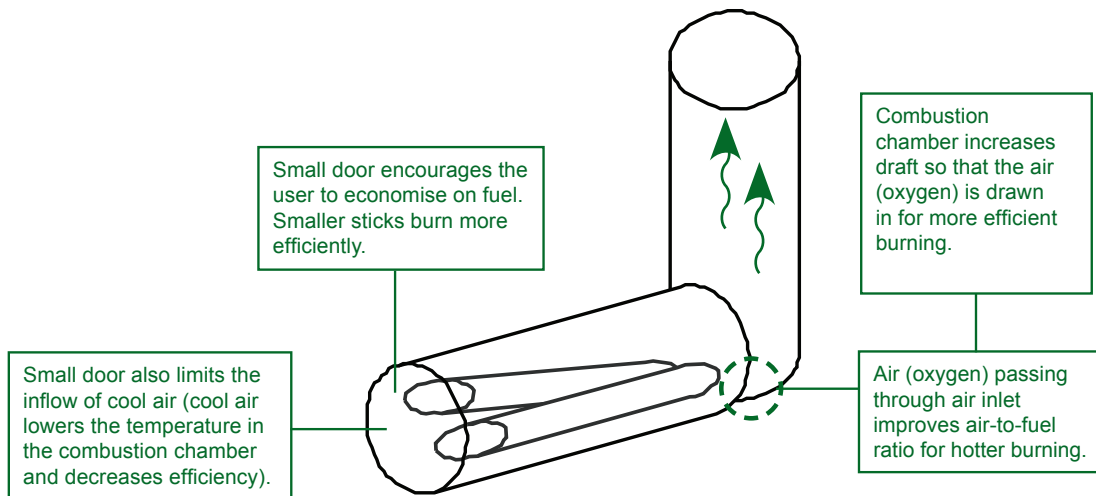

## Parts of the rocket stove

Compare and see how the rocket principle works in practice.

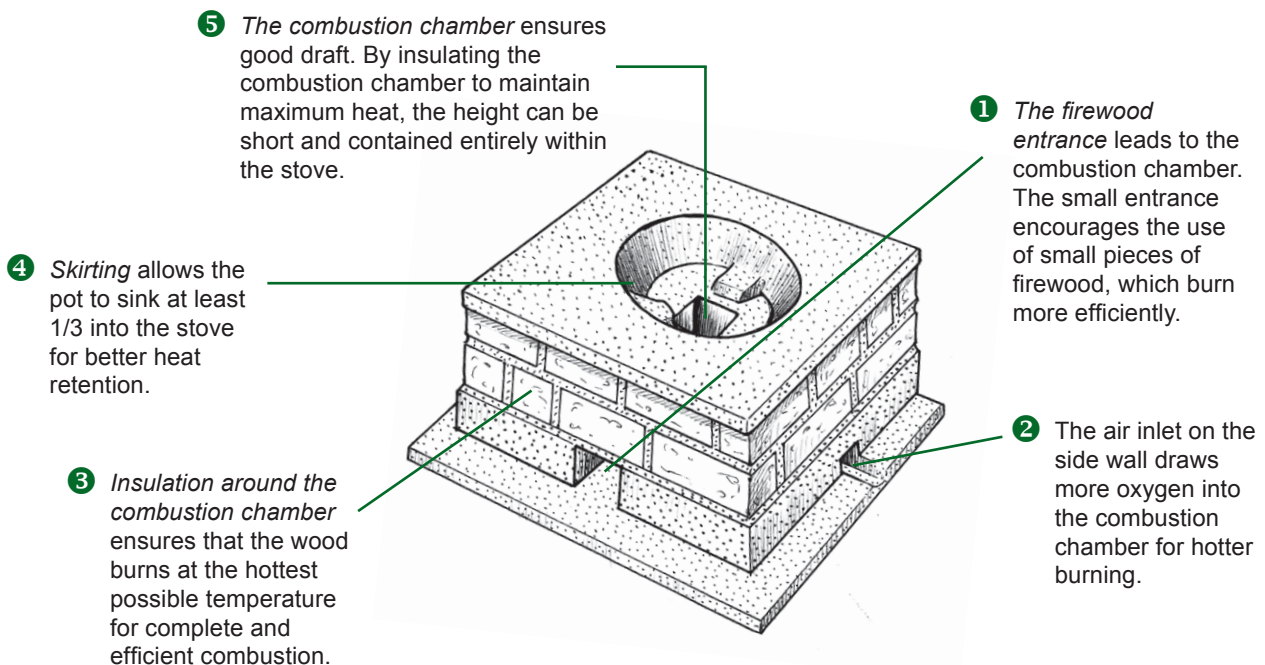

**The combustion chamber of the rocket stove increases draft to enable almost complete burning, hence higher temperatures up to 600°C. This leads to faster cooking, with less firewood and less smoke.**

## Materials needed to build one stove

The rocket brick stove can be built with mortar made from either cement or clay/anthill soil. Follow the quantity of materials and the ratios given in this table.

Rocket brick stove with cement		Rocket brick stove with clay/anthill soil	
Material	Quantity	Material	Quantity
Cement	0.5 bag	Clay or anthill soil	2 wheelbarrows
Sand	3 wheelbarrow loads	Sawdust or chopped grass	2 wheelbarrows of chopped grass OR 1 wheelbarrow of sawdust
Lime	1 bag	Standard-size fired bricks	50 pieces
Standard-size fired bricks	50 pieces	Water	5 buckets
Gravel	1 bucket		
Ash	2 buckets		
Clean water for the mortar	5 buckets		
<b>Ratio for fire chamber, pot rests and skirting</b>	<b>Ratio for outside body</b>	<b>Ratio for fire chamber, pot rests and skirting</b>	<b>Ratio for outside body</b>
4x cement	1x cement	1x clay OR anthill soil	1x clay OR anthill soil
1x lime	1x lime	1x sawdust OR 2x grass	1x sawdust OR 2x grass
1x grog (crushed bricks in particles smaller than 3mm) — OR fire cement	3x sand		

### Cement for the combustion chamber

Cement is not heat resistant and to avoid cracking it is necessary to use a different mortar for the combustion chamber. If the client can afford it, fire cement is recommended for the construction of the combustion chamber. If not, use a mixture of normal cement, lime and grog in the ratios given above.

#### Tools and equipment needed

- Spirit level
- Tape measure
- Masonry trowel
- Masonry wooden flat
- Tri square
- Spade
- Hoe
- Metal mixing basin
- Wheelbarrow

#### Position of the stove

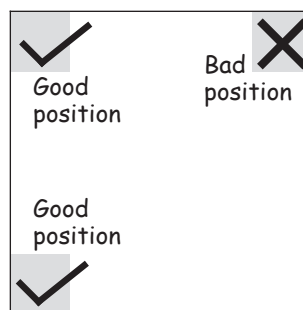

Site the stove at an angle to the kitchen doorway, not directly opposite it.

## Stove plan

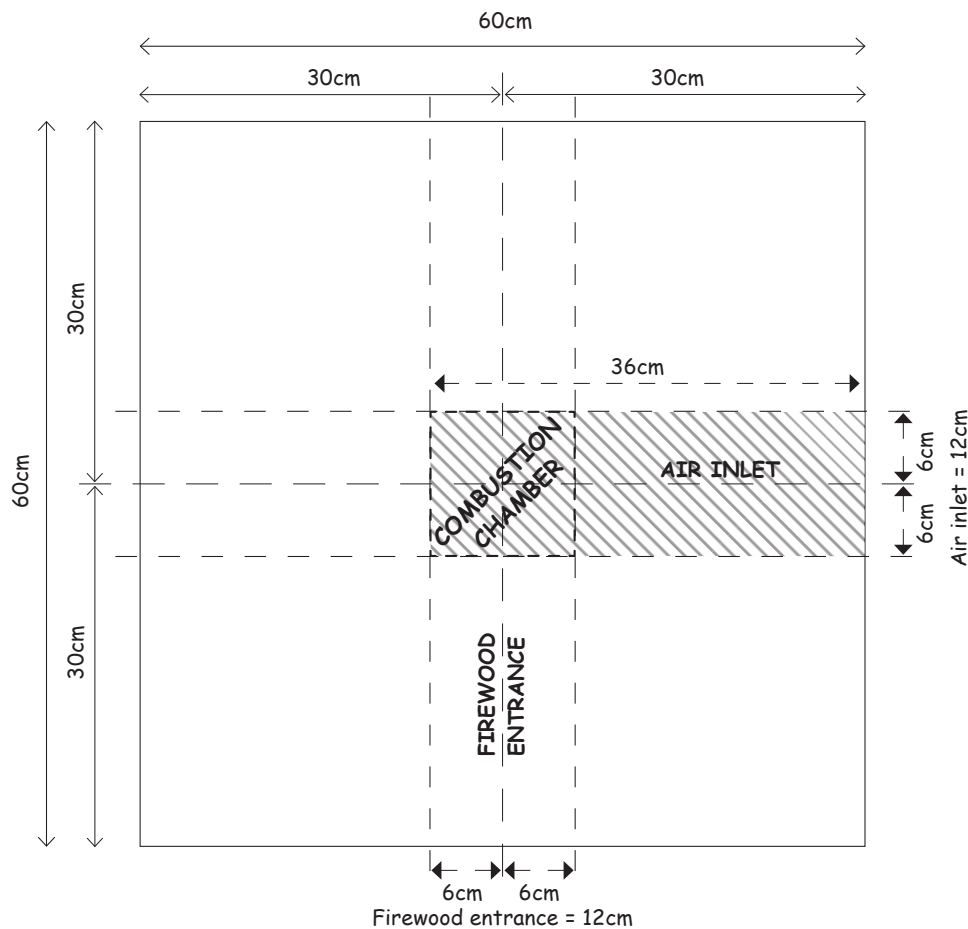

### Basic measurements to remember:

Stove body = 60cm x 60cm square

Firewood entrance in the front = 12cm wide

Air inlet in the middle of one side = 12cm wide x 36cm long x 4cm deep

Combustion chamber in the centre = 12cm x 12cm square

**Hint:** First mark the mid-point of each side of the stove foundation, then draw lines to join the opposite sides. Measuring the firewood entrance and air inlet now become easy.

## Standard brick dimensions

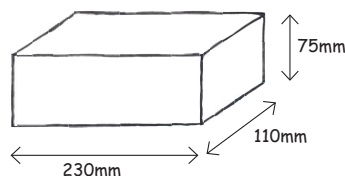

The rocket stove must be built using fired clay bricks of standard size, because then it is easy to observe proper dimensions for the stove, in particular the combustion chamber, during construction.

A standard-size fired clay brick measures 230mm x 110mm x 75mm

## Building a rocket brick stove step-by-step

### 1. MAKING THE FOUNDATION

#### Clay method

**1.1** Using measuring tape and tri square, measure and mark out an area 60x 60 cm where the stove will be built. Dig 6cm deep for the foundation.



**1.2** Pour mixture of clay( with chopped grass or sawdust) into the dug-out foundation area and compact it firmly.



**1.3** Lay 6cm as your base using the mixture of clay with chopped grass or sawdust.

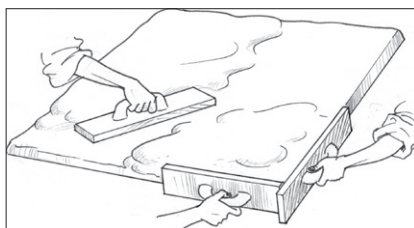

**1.4** Make the foundation slab as smooth and level as possible.

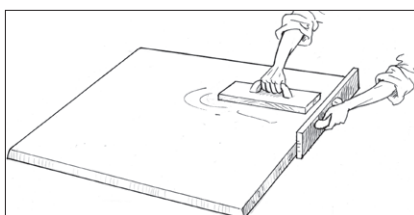

**1.5** Mark the midpoint of each side of the slab and draw lines to join opposite sides. Where the lines cross is the centre of the combustion chamber — mark it with a stick. From the centre, work outwards to make your other measurements. Refer to the stove plan on page 5.

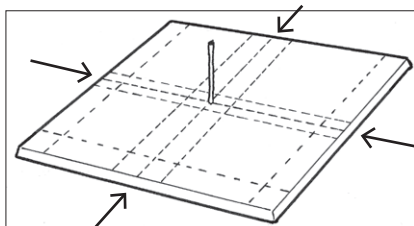

#### Cement method

**1.1** Using a measuring tape and tri square, measure and mark out an area 60 x 60 cm where the stove will be built. Dig 4cm deep for the foundation.

**1.2** Pour hardcore (gravel) into the dug-out foundation area and compact it firmly.

**1.3** Mix mortar using **1 spade cement + 2 spadess sand + 2 spadess gravel**.

Add enough water to mix well. Spread mortar to a height of 2cm over the hardcore, extending mortar a little at each side to make an outer base for the stove.

**1.4** Make the foundation slab as smooth and level as possible.

**1.5** Mark the midpoint of each side of the slab and draw lines to join opposite sides. Where the lines cross is the centre of the combustion chamber — mark it with a stick. From the centre, work outwards to make your other measurements. Refer to the stove plan on page 5.

## 2. CONSTRUCTING THE AIR INLET

### Clay method

**2.1** Dig out a groove 12cm wide x 4cm deep on one side of the foundation slab, through to the other side of the combustion chamber. This will be the air inlet. Smooth the sides and bottom with a little mortar of the clay mixture.

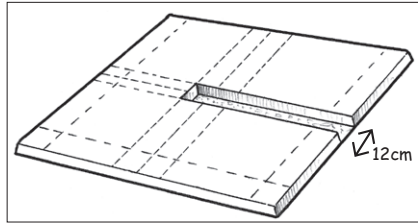

**2.2** Place 2 bricks in the front to mark the door of the firewood entrance. Place 1 brick on the back wall of the combustion chamber. The distance from the front to back should be 36cm.

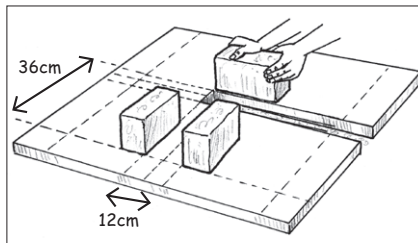

**2.3** Complete the left wall of the combustion chamber and use the clay mixture to fix the bricks into position.

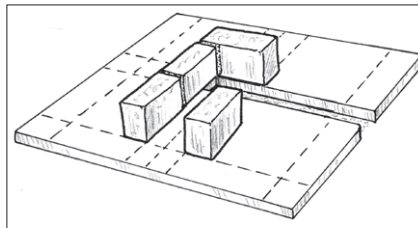

**2.4** Place 4 bricks on either side to line the length of the air inlet.

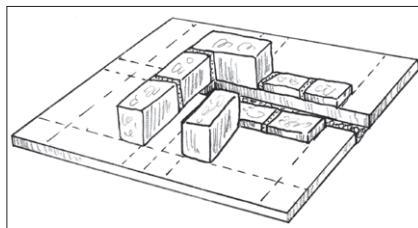

**2.5** Complete the roof of the air inlet with another layer of bricks. Mortar the bricks into position.

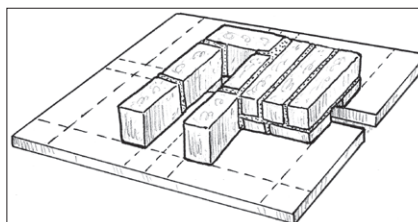

### Cement method

**2.1** Dig out a groove 12cm wide x 4cm deep on one side of the foundation slab, through to the other side of the combustion chamber. This will be the air inlet. Smooth the sides and bottom with a little mortar.

**2.2** Place 2 bricks in the front to mark the door of the firewood entrance. Place 1 brick on the back wall of the combustion chamber. The distance from front to back should be 36cm.

**2.3** Complete the left wall of the combustion chamber with bricks and use fire mortar to fix the bricks into position. For strength, always use fire mortar when constructing the combustion chamber.

**2.4** Place 4 bricks on either side to line the length of the air inlet.

**2.5** Complete the roof of the air inlet with another layer of bricks. Mortar the bricks into position.

### 3. CLOSE THE COMBUSTION CHAMBER AND FINISH THE FIRST LAYER OF BRICKS

#### Clay method

**3.1** Add bricks to close the roof of the combustion chamber and use the clay mixture to fix them into position.

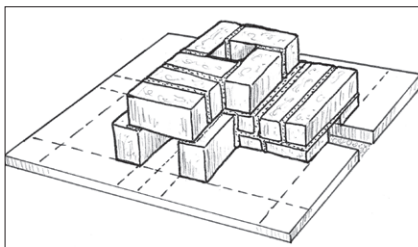

**3.2** Place the bricks for the outer wall of the stove, leaving space for insulation between the outer and inner walls. Mortar the bricks into position to complete the first course.

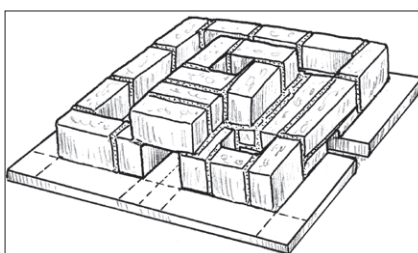

#### Cement method

**3.1** Add bricks to close the roof of the combustion chamber and use fire mortar to fix them into position.

**3.2** Place the bricks for the outer wall of the stove, leaving space for insulation between the outer and inner walls. Mortar the bricks into position to complete the first course.

### 4. MAKING THE SECOND LAYER OF BRICKS

**4.1** Build up the second course of bricks for the outer wall, and mortar them into position using the clay mixture.

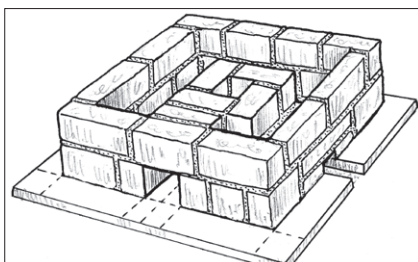

**4.2** Pour the clay mixture into the gaps between the combustion chamber and the outer wall, up to the level of the bricks. This is for insulation. Press down lightly to compact the material so little air remains.

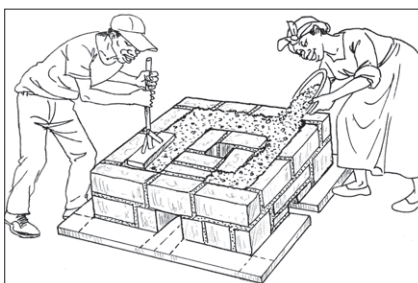

**4.1** Build up the second course of bricks for the outer wall, and mortar them into position. Make sure to check horizontal levels and height at all times.

**4.2** Pour ash, gravel or straw into the gaps between the combustion chamber and the outer wall, up to the level of the bricks. This is for insulation. Press down lightly to compact the material so little air remains.



## Clay method

**4.3** Sprinkle a little water over the insulation to make the surface smooth.

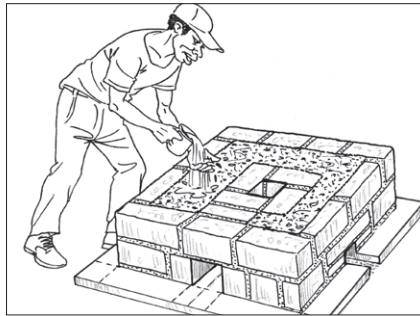

**4.4** Ensure the surface is even and horizontal by using a spirit level and tape measure.



## Cement method

**4.3** Sprinkle a little water over the insulation to prepare the surface for the mortar.

**4.4** Pour a layer of mortar over the whole surface and spread evenly. Make sure no mortar enters the combustion chamber. Ensure the surface is even and horizontal by using a spirit level and tape measure.

## 5. MAKING THE POT RESTS

**5.1** Around the combustion chamber, place 3 pieces of cut brick to make the pot rests — 1 at the back wall, the other 2 on either corner of the front of the chamber. Add more clay mixture as a base to hold the pot rests in position.

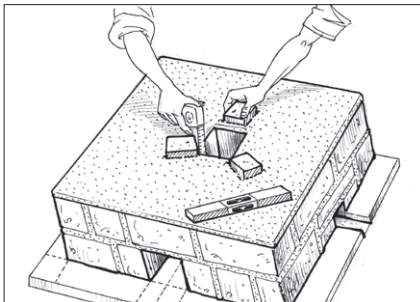

**5.1** Around the combustion chamber, place 3 pieces of cut brick to make the pot rests — 1 at the back wall, the other 2 on either corner of the front of the chamber. Add mortar as a base to hold the pot rests in position.

**5.2** Take the largest pot commonly used by the household, and place it on the pot rests. Check that the pot is level by filling it with water and seeing to the equal distribution of water in the pot. Adjust the mortar under the pot rests if necessary.

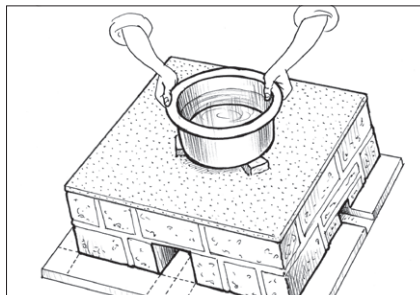

**5.2** Take the largest pot commonly used by the household, and place it on the pot rests. Check that the pot is level by filling it with water and seeing to the equal distribution of water in the pot. Adjust the mortar under the pot rests if necessary.

## 6. MAKING THE THIRD COURSE OF BRICKS

### Clay method

**6.1** Remove the water from the pot and weigh the pot down with bricks to keep it stable. Lay the third course of bricks all around the outside wall of the stove.

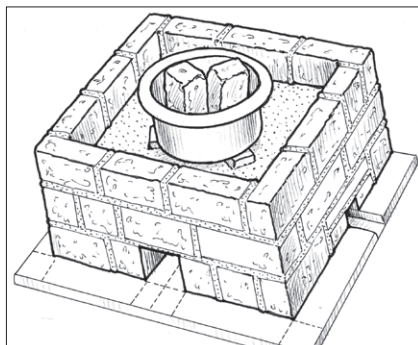

**6.2** Cut 4 or 5 bricks into half and stand the pieces in a circular pattern around the pot, making sure the pot is in the centre.

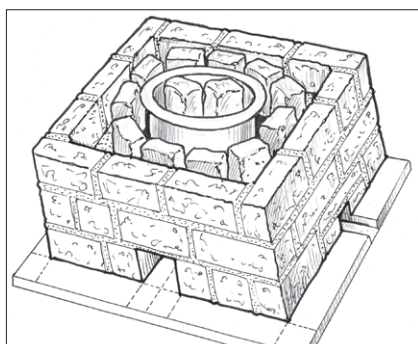

**6.3** Pour the clay mixture into the gaps between the pot and outer wall. Compact the insulating material, then sprinkle with little water as before to make the surface smooth.

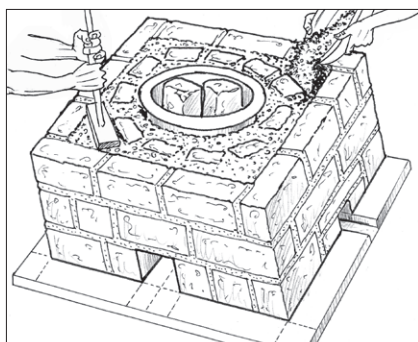

**6.4** Pour the clay mixture on the surface and spread out evenly. Smooth it to about 2.5 cm from the edge of the pot. Ensure that the stove's top surface is uniformly horizontal.

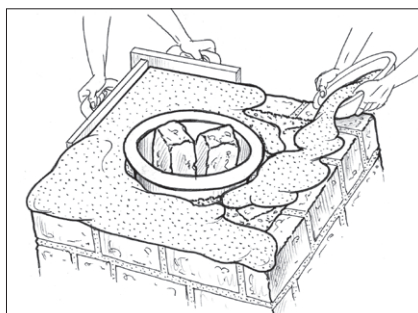

### Cement method

**6.1** Remove the water from the pot and weigh the pot down with bricks to keep it stable. Lay the third course of bricks all around the outside wall of the stove.

**6.2** Cut 4 or 5 bricks into half and stand the pieces in a circular pattern around the pot, making sure the pot is in the centre.

**6.3** Pour ash or gravel into the gaps between the pot and the outer wall. Compact the insulating material, then sprinkle with a little water as before to prepare the surface for mortaring.

**6.4** Pour mortar on the surface and spread out evenly. Smooth it to about 2.5cm from the edge of the pot. Ensure that the stove's top surface is uniformly horizontal.

## 7. NEATEN THE POT RESTS AND FINISH THE STOVE

### Clay method

**7.1** Allow clay mixture to set almost firm, then turn the pot gently in a circular motion, lift it out, and put it back.

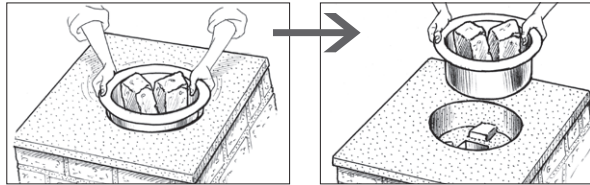

**7.2** On the surface of the mortar, draw a faint line all around the pot, using the outer brim of the pot as your guide.

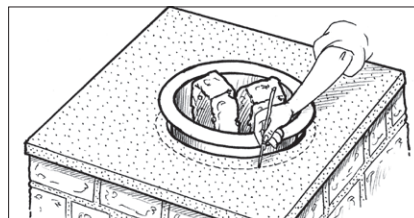

**7.3** Scoop out the excess clay mixture inside the line, going down to the level of the pot rests.

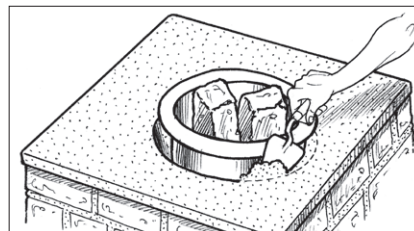

**7.4** Remove the pot and smoothen the sides of the pot rest area, using a little mortar. Wear a rubber glove or protect your hand with a plastic bag. Keep excess clay mixture for the finishing touches.

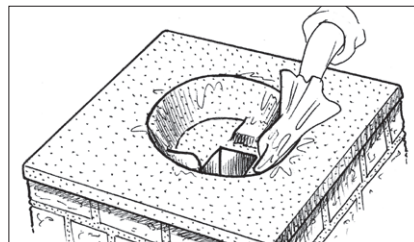

**7.5** Use the extra clay mixture to smoothen the sides and add finishing touches, such as the skirting around the stove. Leave the stove to dry for 3 weeks while covered with a watertight material e.g. polythene bag.

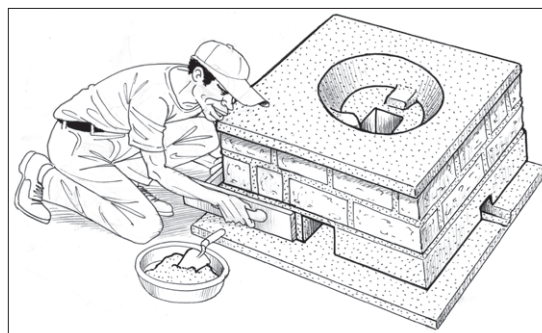

### Cement method

**7.1** Allow mortar to set almost firm, then turn the pot gently in a circular motion, lift it out, and put it back.

**7.2** On the surface of the mortar, draw a faint line all around the pot, using the outer brim of the pot as your guide.

**7.3** Scoop out the excess mortar inside the line, going down to the level of the pot rests.

**7.4** Remove the pot and smoothen the sides of the pot rest area, using a little mortar. Wear a rubber glove or protect your hand with a plastic bag. Keep excess mortar for the finishing touches.



**7.5** Use the extra mortar to smoothen the sides and add finishing touches, such as the skirting around the stove.

## Jinsi ya kutumia jiko lako jipya



### KUMBUKA

- Wacha jiko likauke vizuri kabla ya kulitumia, uwe unasiriba au kunyunyuzia maji ili lisipate kupasuka
- Jiko lako likiwa limejengwa na tope, usilinyunyuzie maji. Lifunike kwa kutamia karatasi lisilingiza maji( polythene)
- Ngoja hadi jiko likauke kabisa, la sivyo litakuwa na shida kuwaka
- Wakati wa mwanzoni, jiko litatumia kuni nyingi kuliko kiasi hadi lizoee moto. Baada ya wiki 2-3 matumizi ya kuni yatakuwa madogo

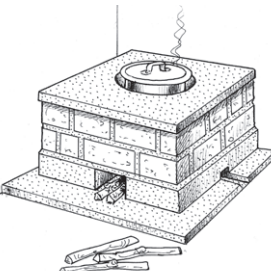
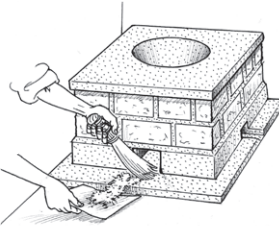
### JINSI YA KUTUMIA KUNI VYEMA

 <p>1. Weka kuni mahali pakavu. Kuni zenye maji zinatoa moto kidogo na matumizi kuwa juu. Pia hutoa moshi.</p>	 <p>2. Kata kuni vipande vidogo vidogo. Huwaka vizuri kuliko kuni hubwa.</p>	 <p>3. Tumia vipande 2-3 tu. Vinginevyo unaharibu kuni na kuleta moshi mwingi.</p>	 <p>4. Fanya usafi wa jiko lako kila mara kabla ya kutumia, toa majivu na usitumie maji.</p>
---	---	--	---

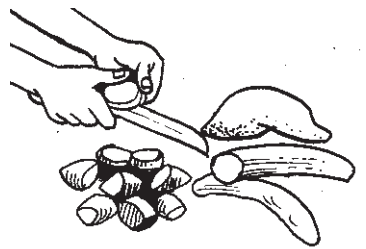
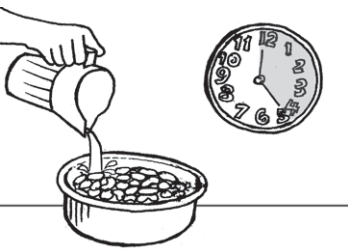
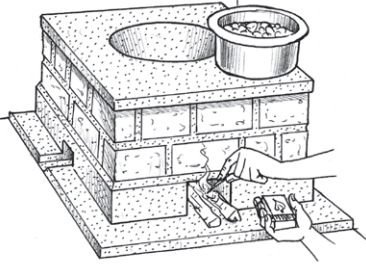
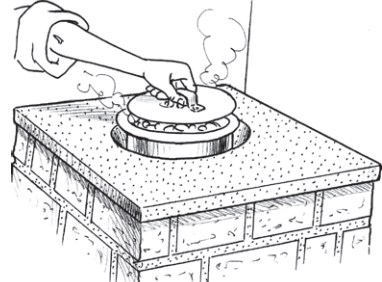
### JIA ZA KUPIKA NA KUPUNGUZA MUDA

 <p>1. Kata chakula kwavipande vidogo vidogo. Chakula kitaiva haraka.</p>	 <p>2. Loweka mahindi/ maharagwe kwa masaa 5 kabla ya kupika. Muda wa kupika utapungua.</p>	 <p>3. Washa moto baada ya kutayarisha chakula unatochotaka kupika.</p>
 <p>4. Funika sufuria ikiwa jikoni hata kama unachemsha maji.</p>	 <p>Fuata hayo maagizo na matumizi yako ya kuni yatapungua kwa kiasi kikubwa Furahia upishi wako katika jiko la Rocket!</p> <p>Fundi wako ni:</p>	