

# OPERATION MANUAL

## Indoor 24 Hour Digital Timer

MODEL NO. 52-8867-6

# NOMA<sup>®</sup><sub>MD</sub>



# Know your product

## FRONT

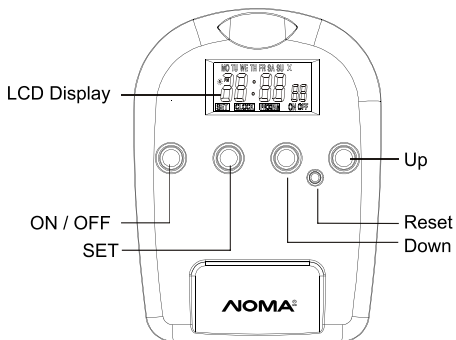

## BACK

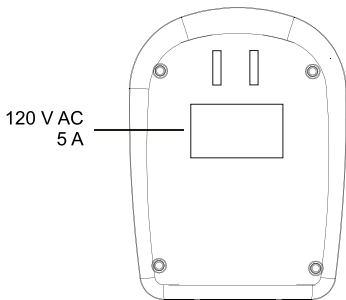

# Introduction

Thank you for buying this Programmable Timer! By setting programs, you can turn on and off any plugged-in electrical appliances at your own selected time.

Operation of this Timer is simple. For optimal use, please read and follow the instructions carefully.

## **Features**

- Real-time clock with Weekday, Hour, Minute and Second reading
- Display in selectable 12 or 24 hour display format
- 6 on/off program pairs with Weekday, Hour and Minute setting
- Settings can operate individually either on a specific day, Monday to Friday, Monday to Saturday or every day
- Daylight Savings Time
- Manual on/off
- Master/individual disable for pre-set program(s)

# LCD Display

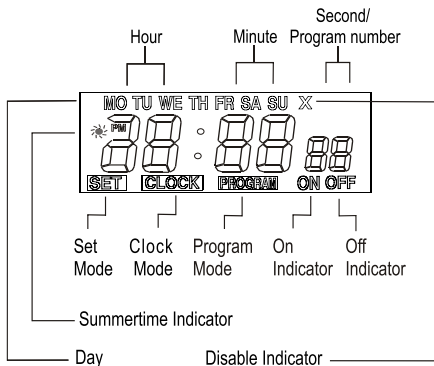

## **Battery Installation**

The 1.5V batteries have already been installed in the Timer. To activate, completely remove the piece of ribbon that is protruding from the battery compartment.

*Note: The batteries serve to back up the clock and programs while the Timer is unplugged. The battery life is around 1 year when the Timer is not connected to the power outlet. If you plan to leave the Timer unplugged for a long period of time, you may want to remove the batteries from the Timer.*

## Reset Function / Abnormal Display

When an abnormal or blank display appears, or if you want to clear all programs, use a round object such as a ball-point pen to push the RESET key. After reset, clock and all programs will be cleared.

If the display is dim or abnormal, you should replace the button cell batteries.

### Operation

The various program modes of the Timer are arranged in a continuous pattern as shown below:

Clock → Pgm.1 On → Pgm.1 Off → Pgm.2 On →  
Pgm.2 Off → Pgm.6 On → Pgm.6 Off → Clock...

The PROG symbol will light up to denote Program is being displayed.

Press either the ▼ or ▲ key to scroll through clock and programs. If the key is pressed for more than 1 second, the key will repeat itself.

To return to the Clock display from other modes, simply press both ▲ and ▼ keys together.

# Setting the Clock

- To set the clock, press the **SET** key while the clock is displayed. **SET** will appear on the display and the day of the week will be flashing.

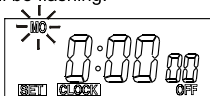

- Press ▼ or ▲ key to select the correct day. Hold the key and it will skip through the days.
- Once the correct day has been selected press **SET** key and *Hour* will be flashing.
- Press ▼ or ▲ key to select the hour
- Press **SET** key and *Minutes* will be flashing.
- Press ▼ or ▲ key to select the minutes
- Press **SET** key and *Seconds* will be flashing
- For the setting of *Seconds*, either ▼ or ▲ key will set the second to 00.
- Press **SET** to exit the clock setting function. The **SET** display will disappear and the Timer will return to the normal clock display.

To change between 12 or 24 hour display, press the **ON/OFF & SET** keys together briefly to toggle between 12 hour and 24 hour display.

## NOTE

Pressing **ON/OFF** alone will disable all programs by placing an X on the screen. Pressing **ON/OFF** again will make the disappear and enable all programs again. This process is covered in depth on Page 9.

# Setting the Program

With this Timer you can set up to 6 On/Off Programs. To set each program, please see the example shown below:

## Example of setting program 1:

### MO 8:15 ON / MO 15:45 OFF

In this example, the Timer will be turned on Monday at 8:15 and off at 15:45.

- Press ▼ or ▲ key until **PROG 1 ON** appears on the Display.
- Press **SET** key and **SET** will appear on the display and *Weekday* will be flashing at the top of the screen.
- Press ▲ key to select the day(s) for Program 1 to be active. The day displayed will sequence through **MO-SU (everyday)**, **MO to SU (individually)**, **MO to FR**, then **MO-SA**, **SA-SU** and repeat again.

In this example, the day would be Monday.

- Press the **SET** key when **MO** appears on the display.
- *Hour* should be flashing. Use ▼ or ▲ key to change The hour to 8, then press the **SET** key.
- *Minute* should be flashing. Change it to 15.  
Press **SET** key to finish the setting of Program 1-On.
- Press ▲ key and **PROG 1 OFF** appears at the display.  
Use the same method to set the off time.

To set more programs, press the ▲ key and **PROG 2 ON** appears. Repeat the above procedures to set all Programs. If no key is pressed for 1 minute, the Timer will return to Clock display automatically.

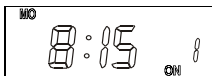
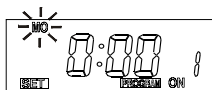

# Summer/ Winter Time

Pressing and holding both ▼ and ▲ keys at the same time in the Clock mode display will change the current time to Summertime mode. The hour will advance by one and the symbol  will light up to denote that the Summertime is activated. Pressing and holding the 2 keys again in Clock mode will return to normal time.

## **Manual On/ Off**

The timer can be turned on or off at anytime by using the **ON/OFF** key without affecting the programs. The flashing **ON** or **OFF** will indicate that the Manual On/Off function is activated.



## Activating the Disable / Master Disable Function

This function allows you to disable any or all of the pre-set On/Off programs. To disable one particular program, display the program you wish to disable, then press the **SET** key. The display will be flashing and the word **SET** will light up.

Press the **ON/OFF** key to disable the program and the **X** symbol will appear to indicate that particular program is disabled.

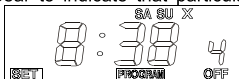

**Note:** If the display is still flashing and there are no changes to be made on the pre-set program time, press the **SET** key until the display is not flashing. Use this function to disable as many available pre-set programs as you choose.

To disable all 6 programs, press the **SET** key while in Clock display, then press the **ON/OFF** key. The **X** symbol will appear on the Clock Display Mode and indicate that all pre-set programs are disabled.

To cancel this Disable function, just use the same method as above to turn off the **X** symbol.

# Caution

This timer is equipped with a 2-pin polarized receptacle. An appliance with a 2-pin power cord is suitable to connect with it. Before plugging the timer in, it is recommended to view the correct polarization of pin. Do not force the plug or power cord into the receptacle. Do not remove the ground pin of a 3-pin plug to plug into the timer receptacle.

## **Technical Specifications**

Program: 6 programs per day or per week

Minimum switching time: 1 minute

Ratings: 120V AC 5A

Maximum load: 600 W

## **WARRANTY**

This Noma® product carries a **1 (one) year** warranty against defects in workmanship and materials.

Trileaf Distribution agrees to replace the defective product free of charge within the stated warranty period, when returned by the original purchaser with **proof of purchase**. This product is not guaranteed against wear or breakage due to misuse and/or abuse.

## **Customer Service**

1-888-468-6876