

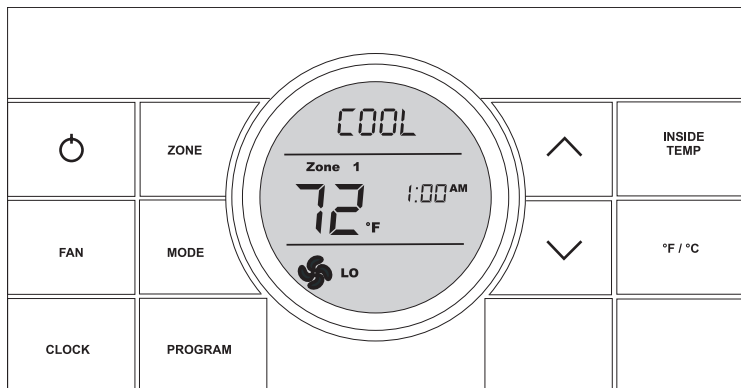

COMFORT CONTROL CENTER 2 THERMOSTAT OPERATING INSTRUCTIONS



PROGRAMMABLE THERMOSTAT

MODEL

3314080.000 BLACK

3314080.015 WHITE

USA

SERVICE OFFICE
Dometic Corporation
1120 North Main Street
Elkhart, IN 46514

CANADA

Dometic Corporation
46 Zatonski, Unit 3
Brantford, ON N3T 5L8
CANADA

For Service Center & Dealer Locations

Please Visit:
www.eDometic.com

REVISION B

Form No. 3314149.018 08/16
(French 3314169.016_B)
©2016 Dometic Corporation
LaGrange, IN 46761

INTRODUCTION

Congratulations! Your recreational vehicle manufacturer has equipped your RV with the most advanced RV thermostat. Your Dometic Comfort Control Center 2 thermostat (hereinafter referred to as the CCC 2 thermostat) has been designed for ease of operation and for many years of reliable service.

Dometic Corporation reserves the right to modify appearances and specifications without notice.

TABLE OF CONTENTS

INTRODUCTION	2
DOCUMENT SYMBOLS	3
ABOUT YOUR NEW THERMOSTAT	3
A. Features	3
B. System Configuration & Initialization	3
C. Quick Reference To Control Buttons	5
D. Quick Reference To LCD Icons	5
PROGRAMMING & OPERATIONS	6
A. ON/OFF	6
B. Clock Setting	6
C. Temperature Format °F / °C	7
D. Inside Temperature	7
E. Zone Selection	8
F. Mode Selection	8
G. Fan Speed	9
H. Temperature Set-Point	9
MODE DESCRIPTION	10
A. "OFF" - Off Mode	10
B. "COOL" - Cool Mode	10
C. "HP" - Heat Pump Mode	10
D. "HS" - Heat Strip Mode	11
E. "FAN" - Fan Mode	11
F. "FURN" / "AQUA" - Furnace Or Aqua (Hydronic) Heating Mode	11
G. "AUTO" - Auto Change Over Mode	12
SPECIAL FEATURES	12
A. Auto Fan	12
B. Zone Control	13
C. Program "1" & "2"	13
D. Examples Of Times Programmed	15
E. CANbus Interface	15
F. Auxiliary Heat (Heat Pump Models Only)	16
G. Stage Select - Two Air Conditioner/Heat Pump Units (Select Models) On One Zone	16
H. Stage Select - Dual Compressor Air Conditioner/Heat Pump (Select Models)	16
I. Auto Generator Start (AGS)	17
J. Load Shed	17
K. Defrost Cycle (Heat Pump Models Only)	17
L. Compressor Time Delay	17
M. Power Interruption	18
N. LCD Error Code	18
SYSTEM RESET PROCEDURE	19
GENERAL INFORMATION	19

TABLE OF CONTENTS

A. Reduce Heat Gain	19
B. Disclaimer	19
MAINTENANCE	20
A. Air Filter	20
B. Dometic CCC 2 Thermostat	20
SERVICE	20

DOCUMENT SYMBOLS

 Indicates additional information that is not related to personal injury.

 Indicates step-by-step instructions.

ABOUT YOUR NEW THERMOSTAT

A. Features

- Liquid Crystal Display
- Two operation programs
- Constant time of day display
- Remote Sensor (Precise comfort control within 1 °F of set-point)
- Display reminder lets you know when to service or replace filters
- Up to four independent zones

To help familiarize yourself with the operation of the CCC 2 thermostat, review the following diagrams and accompanying text that explain the functional characteristics of this system.

Your CCC 2 thermostat is equipped with a liquid crystal display (LCD) that identifies the mode of operation (OFF, Cool, Heat Pump, Fan, Heat Strip, Auto, & Furnace or Aqua), temperature set-point, zone identification (“1”, “2”, “3”, “4”), fan speed (“Auto,” “Low,” “Med,” “High”), program “1” and “2”, inside temperature, clock, °F / °C, compressor delay, and filter maintenance. The modes of operation viewed in the LCD will vary depending on the system installed in your RV.

B. System Configuration & Initialization

The installer of your system will set the required system DIP switches to the ON position. In order for the CCC 2 thermostat to recognize the system zones, type of units installed and their options, a system reset must be done.

ABOUT YOUR NEW THERMOSTAT

Once the system is completely installed, do a system reset:

1. Make sure the CCC 2 thermostat is in the OFF mode. See section, "C. Quick Reference To Control Buttons" on page (5).
2. Simultaneously press and hold the **MODE** and **ZONE** buttons. See section, "C. Quick Reference To Control Buttons" on page (5).
3. The LCD will display "IniT" and all available zones.
4. Release the **MODE** and **ZONE** buttons.
5. Press the **ON/OFF** button to exit system set up.
6. The furnace ON/OFF temperature differential should be set at this time. For further information on furnace mode differential setting, see section, "F. "FURN" / "AQUA" - Furnace Or Aqua (Hydronic) Heating Mode" on page (11).

Any time a system reset occurs, the factory default settings are restored. See table, "Factory Preset Settings" on page (4).

In the unlikely event of CCC 2 system memory loss or dip switch setting change, the CCC 2 thermostat will require a system reset. For system reset procedure, see main heading, "System Reset Procedure" on page (19).

Your Dometic CCC 2 thermostat has been pre-programmed. Review settings below and adjust the settings to your personal comfort level.

 Any time the CCC 2 is in an idle stage (not illuminated) you will need to wake it up by pressing any button on the CCC 2 before it will recognize a new setting attempt.

Factory Preset Settings	
All Zones	
Function	Setting
Time of Day (Clock)	— — —
Each Zone	
Heating	68 °F / 20 °C
Cooling	72 °F / 22 °C
Automatic	70 °F / 21 °C
Fan Speed	Auto
Mode	Off

Factory Preset Settings Each Zone	
Program "1"	
Function	Setting
Heating	68 °F / 20 °C
Cooling	72 °F / 22 °C
Automatic	70 °F / 21 °C
Fan Speed	Auto
Mode	Off
Time	8:00 AM
Program "2"	
Heating	68 °F / 20 °C
Cooling	72 °F / 22 °C
Automatic	70 °F / 21 °C
Fan Speed	Auto
Mode	Off
Time	10:00 PM

ABOUT YOUR NEW THERMOSTAT

C. Quick Reference To Control Buttons

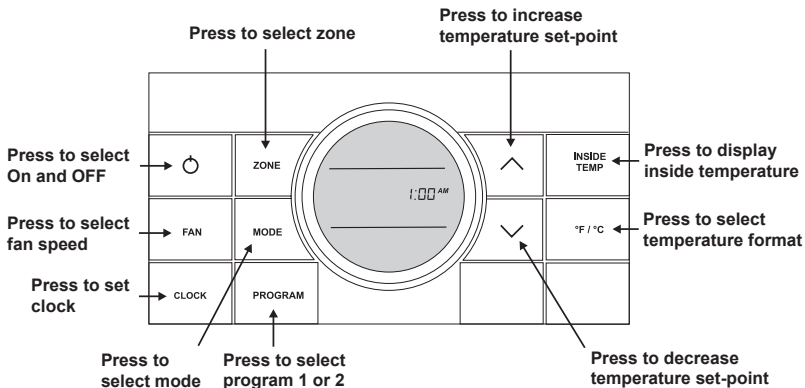

D. Quick Reference To LCD Icons

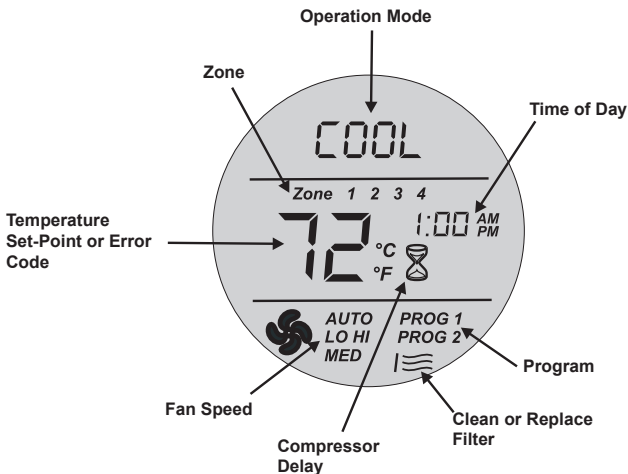

PROGRAMMING & OPERATIONS

A. ON/OFF

To turn ON the CCC 2 thermostat when the back light is OFF, first press any button to wake up the CCC 2 thermostat. Then press and release the **ON/OFF** button. The LCD will display the last programmed settings. To turn OFF the CCC 2 thermostat press the **ON/OFF** button and release. Only the time of day will display when the CCC 2 thermostat is in the OFF condition.

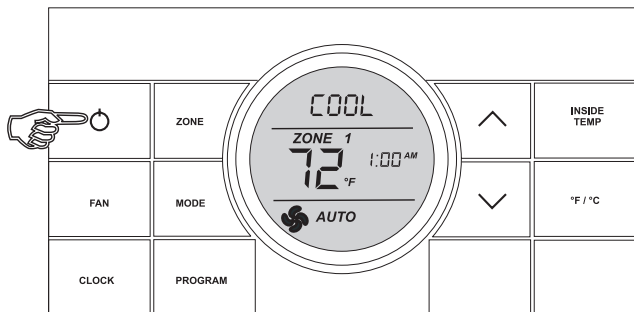

B. Clock Setting

Press the **CLOCK** button to initiate the clock setting sub-menu on the CCC 2 thermostat. When in this menu, the **hour** digits will flash first. The hour can be adjusted using the \wedge or \vee buttons. Press the **CLOCK** button again and the **minute** digits will flash, allowing the minute setting to be adjusted using the \wedge or \vee buttons. Press it a third time and the **AM** or **PM** icon will flash, allowing the AM or PM setting to be adjusted using the \wedge or \vee buttons. Press it one more time to store the new time in memory and exit the clock setting sub-menu.

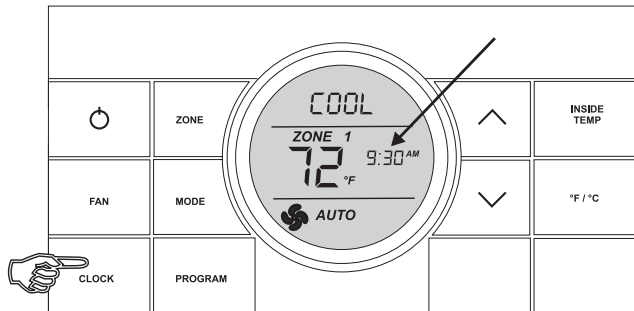

PROGRAMMING & OPERATIONS

C. Temperature Format °F / °C

Press the °F / °C button to switch between Fahrenheit and Centigrade format. “°F” indicates Fahrenheit and “°C” indicates Centigrade.

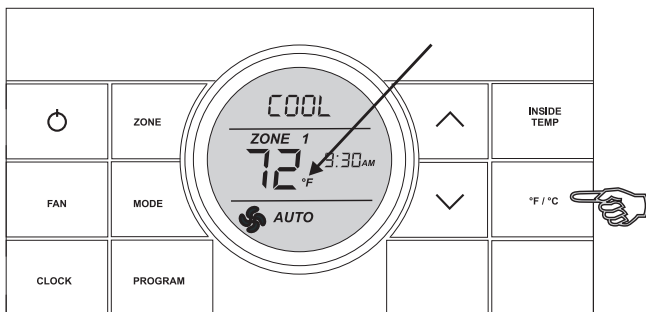

D. Inside Temperature

Press and hold the **INSIDE TEMP** button and the LCD will display the current inside temperature recorded at the CCC 2 thermostat (or at the optional remote indoor temperature sensor) instead of the temperature set-point. The LCD will also display "IN" to indicate that the inside temperature is being displayed. When the **INSIDE TEMP** button is released, the LCD will return to the programmed temperature set-point.

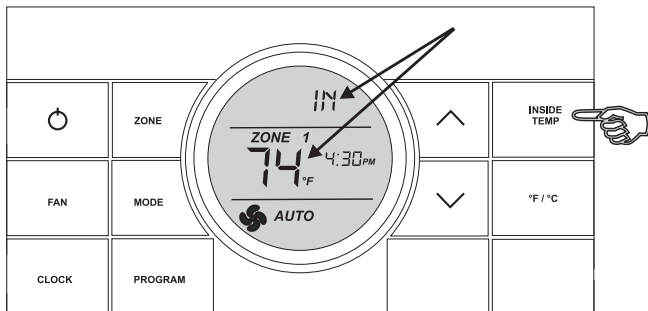

E. Zone Selection

Press the **ZONE** button to cycle the LCD display through the available zone selections; “Zone 1”, “Zone 2”, “Zone 3”, and “Zone 4”. Only the available zones installed within your system will display. For more information on zones, see section, “B. Zone Control” on page (13).

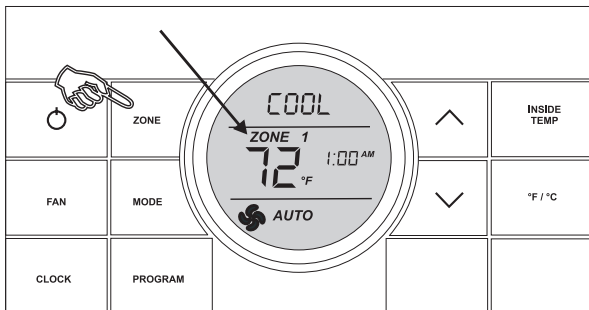

F. Mode Selection

Press the **MODE** button and the LCD will display the first available mode. Each successive press will advance to the next available mode. Continue to press the **MODE** button until the desired mode appears. Depending on the systems installed, your choices will be “OFF”, “COOL”, “AUTO”, “HP”, “FURN” or “AQUA”, “HS”, and “FAN”. For more information on modes, see main heading, “Mode Description” on page (10).

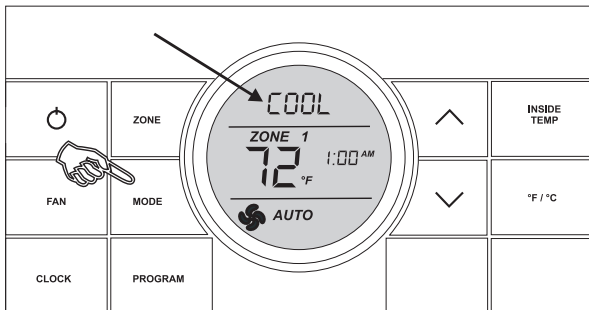

G. Fan Speed

Press the **FAN** button to select the desired fan speed. Each successive press will advance to the next available speed. Your selections will be "Auto", "LOW", "MED", and "HIGH". The fan will run continuously during "LOW", "MED", and "HIGH" fan settings. The fan will cycle ON and OFF with the thermostat on "AUTO" setting. For more information on auto fan, see section, "A. Auto Fan" on page (12).

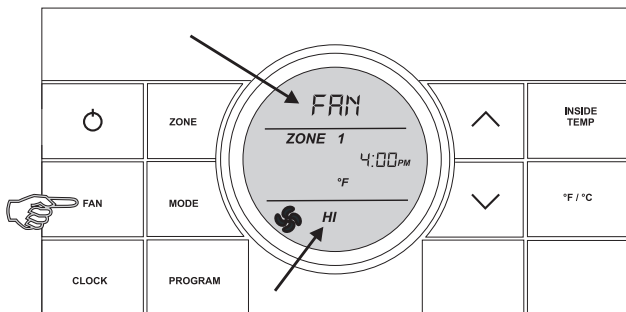

H. Temperature Set-Point

Press the \wedge or \vee button to change the temperature set-point. The temperature set-point is indicated by (2) digits on the LCD. Press the \wedge button to increase and the \vee button to decrease the temperature set-point. The maximum set-point for the system is 90 °F (32 °C). The minimum set-point is determined by the active operating mode. For heating, the minimum is 40 °F (4 °C) and minimum for cooling is 55 °F (13 °C).

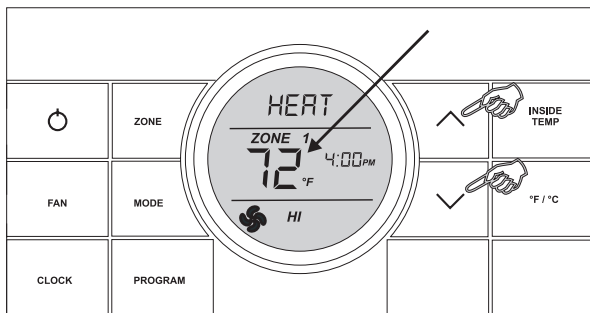

MODE DESCRIPTION

A. "OFF" - Off Mode

Displays **OFF** mode in a zone.

B. "COOL" - Cool Mode

In the **COOL** mode the system will cycle the compressor ON and OFF based on the room air temperature and the temperature set-point on the CCC 2 thermostat. When the system calls for cooling there will be a delay of approximately 2 minutes. During this delay, the hour glass icon will be displayed in the LCD. In auto fan, the fan will turn ON first followed by the compressor in approximately 15 seconds. In this mode there are (4) fan speed selections:

LOW: The fan operates continuously at low speed. The compressor cycles ON and OFF.

MED: The fan operates continuously at medium speed. The compressor cycles ON and OFF.

HIGH: The fan operates continuously at high speed. The compressor cycles ON and OFF.

AUTO: When auto fan is selected the fan speed will vary depending on the difference between the temperature set-point and the room temperature. In auto fan the compressor and the fan will cycle ON and OFF with the thermostat. The compressor shuts OFF first followed by the fan in approximately 15 seconds. For more information on auto fan, see section, "A. Auto Fan" on page (12).

C. "HP" - Heat Pump Mode

In the **HP** mode the system will cycle the compressor ON and OFF based on the room air temperature and the temperature set-point on the CCC 2 thermostat. When the system calls for heating there will be a delay of approximately 2 minutes. During this delay, the hour glass icon will be displayed in the LCD. In auto fan, the compressor will turn ON first followed by the fan in approximately 15 seconds. In this mode there are (4) fan speed selections:

LOW: The fan operates continuously at low speed. The compressor cycles ON and OFF.

MED: The fan operates continuously at medium speed. The compressor cycles ON and OFF.

HIGH: The fan operates continuously at high speed. The compressor cycles ON and OFF.

AUTO: When auto fan is selected the fan speed will vary depending on the difference between the temperature set-point and the room temperature. In auto fan the compressor and fan will cycle ON and OFF with the thermostat. The compressor shuts OFF first followed by the fan in approximately 15 seconds. For more information on auto fan, see section, "A. Auto Fan" on page (12).

MODE DESCRIPTION

D. “HS” - Heat Strip Mode

In the **HS** mode the system will cycle the heat strip ON and OFF based on the room air temperature and the temperature set-point on the CCC 2 thermostat. In this mode there are (4) fan speed selections:

LOW: The fan operates continuously at low speed. The heat strip cycles ON and OFF.

MED: The fan operates continuously at medium speed. The heat strip cycles ON and OFF.

HIGH: The fan operates continuously at high speed. The heat strip cycles ON and OFF.

AUTO: The fan operates in low speed and will cycle ON and OFF with the thermostat.

E. “FAN” - Fan Mode

In **FAN** mode there are (4) fan speed selections:

LOW: The fan operates continuously at low speed.

MED: The fan operates continuously at medium speed.

HIGH: The fan operates continuously at high speed.

AUTO: The fan will be OFF.

F. “FURN” / “AQUA” - Furnace Or Aqua (Hydronic) Heating Mode

(Factory setting is “**FURN**”)

To change the setting from “**FURN**” to “**AQUA**” or vice versa, simultaneously press the \wedge and \vee buttons. The LED will display the selected option.

In the **FURN / AQUA** mode the system will cycle the RV’s furnace/aqua ON and OFF based on the room air temperature and the temperature set-point on the CCC 2 thermostat. The system can be configured to operate using an ON/OFF differential of either 1 °F / °C or 2 °F / °C. This feature is programmed during the system initialization. See section, “B. System Configuration & Initialization” on page (3).

To set the 1 °F / °C differential, simultaneously press the **PROGRAM** button and the \wedge button (“dIF1” will appear in the display while the buttons are pressed). To set the 2 °F / °C differential, simultaneously press the **PROGRAM** button and the \vee button (“dIF2” will appear in the display while the buttons are pressed). In this mode there are (4) fan speed selections:

LOW: The fan operates continuously at low speed.

MED: The fan operates continuously at medium speed.

HIGH: The fan operates continuously at high speed.

AUTO: The fan is OFF.

MODE DESCRIPTION

G. "AUTO" - Auto Change Over Mode

In the **AUTO** mode the system will automatically change the mode of operation from cool to heat or from heat to cool. In order for this mode to operate, the zone being programmed must contain either a heat pump, heat strip or furnace heating source. When in the **AUTO** mode, all pre-programmed operations for the heat pump, heat strip, and furnace will apply.

Auto Change Over Cooling: If the room temperature rises above the temperature set-point by 2 °F / °C, the air conditioner will turn ON until the room temperature reaches the temperature set-point at which time the air conditioner will cycle OFF.

Auto Change Over Heating: If the room temperature goes below the temperature set-point by 2 °F / °C, the available heat source will be cycled ON until the room temperature reaches the temperature set point at which time it will cycle OFF.

If more than one heat source is available on this zone, the priority for selecting the heat source will be heat pump (first), furnace (second), and heat strip (third).

SPECIAL FEATURES

A. Auto Fan

When "AUTO" fan is selected, the fan speed will vary depending on the difference between the temperature set-point and the room temperature. In "AUTO" fan, the compressor and fan will cycle ON and OFF with the thermostat.

When the difference is:

8 °F / °C or more	The fan operates on HIGH
5 to 7 °F / °C	The fan operates on MED
4 °F / °C or less	The fan operates on LOW

B. Zone Control



Zones are established at the time of the installation of your Dometic CCC 2 thermostat. A zone is an area of cooling/heating which is controlled independently by the CCC 2 thermostat. The CCC 2 thermostat allows for four zones (Air Conditioner/Heat Pump) to be set up and run independent of each other. If you have one air conditioner/heat pump installed, you will have one zone. If your RV has more than one cooling/heating system, you may have two, three, or four zones.

Your CCC 2 thermostat will operate cooling and heating appliances that your vehicle manufacturer has designed to cool or heat specific areas (zones) of your RV. The CCC 2 thermostat will advise you of the number of zones in your RV. The zones are displayed “1”, “2”, “3”, or “4” in the LCD readout. See section, “D. Quick Reference To LCD Icons” on page (5).

In the event your vehicle has multiple zones designed, you have the freedom of selecting different modes of operations for each zone. To change from one zone to another, press the **ZONE** button on the CCC 2 thermostat. Each time the button is pressed and released the indicator will change the zone data displayed. When the zones have been programmed, the zones in operation will be displayed. To program each zone, simply repeat the programming steps shown under main heading, “Programming & Operations” on page (6).

C. Program “1” & “2”

The Dometic CCC 2 thermostat can store two operating programs. Each program can be set on individual zones with different mode and time settings for each zone. For each event the user can program the operating mode, fan speed, temperature set-point, and the time of day for the event.

-  1. Select the zone to be programmed.
2. Select program “1” by pressing the **PROGRAM** button. “PROG 1” icon will blink on the LCD display.
3. Press the **CLOCK** button to set the time of day for program to start.
4. Press the **MODE** button to select the mode of operation.
5. Press the **FAN** button to select the fan speed.
6. Press the **PROGRAM** button to save the “PROG 1” settings. LCD will now display “PROG 2”.
-  To set program “2”, repeat steps (3) through (5).
7. Press the **PROGRAM** button again to save program(s) in memory.
-  Depending on the time of day, program “1” or “2” will begin immediately. For instance, if program “1” is set to begin at 10:00 AM and the time of day is 10:30 AM, program “1” will begin immediately. On the other hand, if program “1” is set to 10:00 AM and program “2” is set to begin at 6:00 PM and the time of day is 7:00 PM, program “2” will begin immediately.

SPECIAL FEATURES

When program "1" or "2" is operating, the "PROG 1" or "PROG 2" icon will be displayed in the LCD. The zone will continue to operate in the programmed setting until the program is manually cancelled.

To cancel the program operation, press and hold the **PROGRAM** button for 3 seconds. The zone will be restored to normal operation.

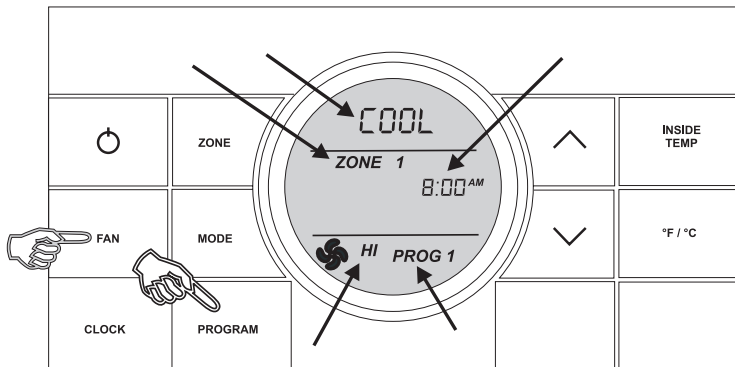

SPECIAL FEATURES

D. Examples Of Times Programmed

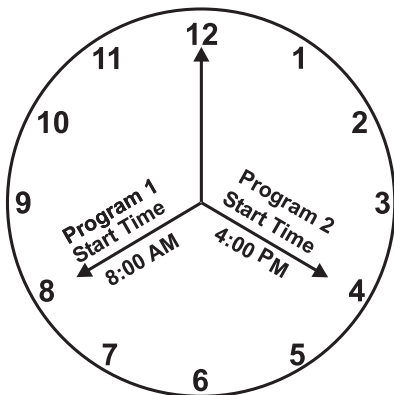
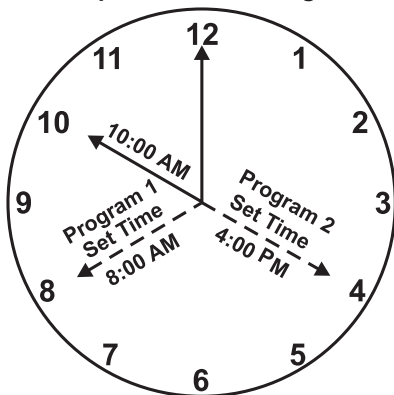

In this example, the zone will operate in program 1 time period until 4:00 PM.
At this time it will switch over to program 2.

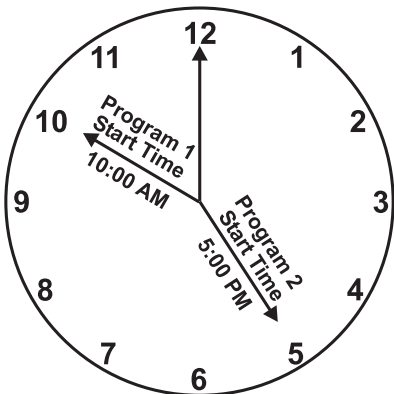
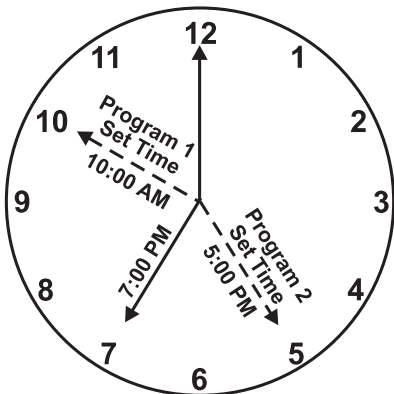

In this example, the zone will operate in program 2 time period until 8:00 AM.
At this time it will switch over to program 1.

E. CANbus Interface

The CANbus interface is designed to communicate between the Dometic CCC 2 thermostat and a CAN (Controller Area Network) protocol generator. Refer to the CANbus installation instructions for more information on installation and operation of the CANbus.

SPECIAL FEATURES

F. Auxiliary Heat (Heat Pump Models Only)

Auxiliary heat operation will be activated when the measured temperature of the outdoor temperature sensor is less than 30 °F (-1 °C). If the system is equipped with a furnace, the control will select **FURN** heating mode for the auxiliary heat source. Auxiliary heat operation, once initiated, will have priority over a heat pump defrost cycle. Auxiliary heat operation will be de-activated and the heat pump operation will resume when the temperature of the outdoor temperature sensor is higher than 35 °F (2 °C).

G. Stage Select - Two Air Conditioner/Heat Pump Units (Select Models) On One Zone

This system can be configured to run two air conditioner/heat pump units using the same temperature set-point for controlling the comfort level in one zone. One unit is designated as the primary stage and the other unit is designated as the secondary stage. The power module boards in both units will use the same DIP switch selection for the Zone (for example, both will be set to "Zone 2"). On the unit designated "secondary" the power module board DIP switch identified as "Ext Stage" must be set to the ON position in order to configure the power module board for the on-demand secondary stage operation (in this example "Zone 2" and "Ext Stage" DIP switches are in the ON position). In this stage configuration, the CCC 2 thermostat temperature set-point will be used for both the primary and the secondary stage air conditioner/heat pump. Only one indoor temperature sensor is required for this configuration and it must be installed in the power module board configured as the primary control.

The turn ON time for the compressors and fans will be controlled to ensure that compressors on the system start one-at-a-time. A minimum delay of 20 to 30 seconds is required between compressor starts.

H. Stage Select - Dual Compressor Air Conditioner/Heat Pump (Select Models)

The Dometic CCC 2 thermostat will operate an air conditioner/heat pump unit with two compressors. On dual basement air conditioner/heat pump units, a single power module board is used to control the operation of two compressors in one air conditioner/heat pump. This system is designed to optimize comfort and operating efficiency by providing an on-demand secondary stage of operation. The CCC 2 thermostat will allow the user to set the primary temperature set-point. The set-point for the secondary stage is preset at a differential of 3 °F / °C from the primary temperature set-point (that is, +3 °F / °C for cooling and -3 °F / °C for heating).

Example: In the cooling mode with the set-point set to 72 °F, the primary air conditioner will cycle ON when the room temperature is ≥ 73 °F. The secondary stage compressor will cycle ON when the temperature is ≥ 75 °F. In the heating mode with the set-point at 72° F, the primary compressor will cycle ON when the temperature is ≤ 71 °F. The secondary stage compressor will cycle ON when the room temperature is ≤ 69 °F.

SPECIAL FEATURES

I. Auto Generator Start (AGS)

On RVs equipped with an optional AGS Kit, the vehicle generator will automatically start when any zone calls for cooling and will shut OFF when zones reach set point.

The Auto Generator Start (AGS) function will be implemented by an individual power module board configured for this function by setting the **GEN Start** DIP switch ON. On the AGS power module board a relay shall be used to provide a start signal to the generator. The normally open relay contacts are utilized and the closure of these contacts provides the signal to start the generator. The AGS relay shall be activated when any zone or stage requires cooling, heat pump or heat strip operation. When a zone calls for heating or cooling, the AGS relay shall be closed, followed by a time delay to allow the generator to warm up after which time the output relay will be activated on the zone that initiated the heating or cooling request. When the heat/cool requests in all zones have been satisfied, the AGS relay will open and the generator will shut-down.

J. Load Shed

The Dometic CCC 2 thermostat has provisions for Load Shedding. The AC power module board shall provide the 12 Vdc source for the Load Shed signal. This 12 Vdc source shall be turned ON 1 second before the compressor relay when the system calls for the compressor to be ON. The Load Shed source shall remain ON when compressor is caused to turn OFF due to being disabled by either a Freeze Sensor or a Load Shed condition. The load shed source signal will be switched to the Load Shed input by the normally open contacts or an off-board relay from the RV power management system. When the Load Shed signal is detected, the compressor shall turn OFF.

K. Defrost Cycle (Heat Pump Models Only)

To avoid frost formation on the outside coil and to obtain maximum performance when the outside temperature is less than 42 °F (6 °C) and greater than 30 °F (-1 °C), a defrost cycle will be initiated. While operating in this temperature range the compressor continuous run time is limited to 25 minutes. When this time is accumulated, the fan will shut OFF, the refrigerant flow will be reversed, and the compressor will continue to run for 4.5 minutes. During this 4.5 minute period, the LCD will toggle between HP and Defrost. The refrigerant flow will then be reversed and after a 30 second delay the fan will resume operation. This cycle will remove any frost formation on the outside coil. This cycle will repeat itself until the outside temperature is greater than 42 °F (6 °C). If the outside temperature becomes less than 30 °F (-1 °C) the heat pump will shut OFF and the auxiliary heat (if provided) will turn ON.

L. Compressor Time Delay

A time delay of approximately 2 minutes occurs any time the compressor is required to begin the cooling or heat pump cycle.

SPECIAL FEATURES

M. Power Interruption

In the event the power to the air conditioner or control is interrupted, the system will restart with the previous set points once power is restored.

N. LCD Error Code

When the system determines that one of the faults listed below has occurred an error code will be displayed in the LCD for the zone in which the error occurred. During normal operation, a blinking zone number indicates a fault has occurred. The error code is displayed in place of the temperature set-point.

Error Code:

- E1 Loss of communication between the CCC 2 thermostat and all system power module boards. System will shut down.
- E1 Loss of communication between the CCC 2 thermostat and an individual system power module board. The LED will display error code "E1" and the zone number that lost communication. Any additional zones that loose communication will blink in addition to the current zone.
- E2 Open circuit or out-of-range Indoor Temperature Sensor. All heat and cool operation will be locked out. Manual fan operation will continue.
- E3 Shorted Indoor Temperature Sensor. All heat and cool operation will be locked out. Manual fan operation will continue.
- E4 Open circuit or out of range Outdoor Temperature Sensor (select models). Heat pump operation will be locked out. Air conditioner, furnace, heat strip, and fan operation can continue to operate.
- E5 Open circuit or out-of-range Freeze Sensor. Air conditioner operation will be locked out. Heat pump, furnace, heat strip, and fan operation can continue to operate but displays the last temperature set-point.
- E7 Loss of 120 Vac power to all power module boards on the system. The system will shut down.
- E8 Invalid zone configuration. The heat pump and heat strip DIP switches are both set to the ON position in one zone. Heat pump, heat strip and air conditioner operation will be locked out in the affected zone.
- E9 Invalid zone configuration. The dehumidifier DIP switch and either the heat pump or heat strip DIP switches are set to the ON position in one zone. Heat pump, heat strip, and air conditioner operation will be locked out in the affected zone.

SYSTEM RESET PROCEDURE

When your unit was installed the appropriate dip switches on the electronic control board were turned ON to match your system configuration. Any time these settings are changed, a system reset will need to be done before the CCC 2 thermostat will recognize the updated selection.

To do a system reset:

1. Make sure the CCC 2 thermostat is in the OFF mode.
2. Simultaneously press the **MODE** and **ZONE** buttons. The LCD will display “IniT” and all available zones.
3. Release the **MODE** and **ZONE** buttons.
4. Press the **ON/OFF** button to exit system set up.

GENERAL INFORMATION

A. Reduce Heat Gain

The ability of the air conditioner to maintain the desired inside temperature depends on the heat gain of the RV. Some preventative measures taken by the occupants of the RV can reduce the heat gain and improve the performance of the air conditioner. During extremely high outdoor temperatures, the heat gain of the RV may be reduced by:

- Parking the RV in a shaded area.
- Using window shades (blinds and/or curtains).
- Keeping windows and doors shut or minimizing usage.
- Avoiding the use of heat producing appliances.

Operation on High Fan/Cooling mode will give optimum or maximum efficiency in high humidity or high outside temperatures.

Starting the air conditioner early in the morning and giving it a “head start” on the expected high outdoor ambient will greatly improve its ability to maintain the desired indoor temperature.

For a more permanent solution to high heat gain, accessories like Dometic outdoor patio and window awnings will reduce heat gain by removing the direct sun. They also add a nice area to enjoy company during the cool of the evening.

B. Disclaimer

The manufacturer of this unit will not be responsible for damage caused by condensation forming on ceilings, windows, or other surfaces. Air contains water vapor which condenses when temperature of a surface is below Dew point. During normal operation this unit is designed to remove a certain amount of moisture from the air, depending on the size of the space being conditioned. Keeping doors and windows closed when this air conditioner is in operation will greatly reduce the chance of condensation forming on interior surfaces.

MAINTENANCE

A. Air Filter



Periodic cleaning or replacement of the air conditioner/heat pump air filters is required. **NEVER** run the air conditioner without the air filter in place. This may plug the unit evaporator coil with dirt and may substantially degrade the performance of the unit over time.

When a system fan run time exceeds 1000 hours the filter icon is displayed in the LCD. (See section, "D. Quick Reference To LCD Icons" on page (5).) When this occurs wash the filter with soap and warm water. Let dry and reinstall.

To reset the fan run time and clear the filter icon, hold the **INSIDE TEMP** and **°F / °C** buttons for 3 seconds. This will clear the fan run time for the current zone selected.

B. Dometic CCC 2 Thermostat



DO NOT spray water directly on the CCC 2 thermostat. **DO NOT** use solvents for cleaning.

Clean the CCC 2 thermostat with a moist soft cloth.

SERVICE

In the unlikely event the unit fails to operate or operates improperly, check the following before calling your service center.

- If RV is connected to a motor generator, make sure the motor generator is running and producing power.
- If RV is connected to a power supply by a land line, make sure the line is sized properly to run air conditioner load and it is plugged into the power supply.
- Check the 120 Vac fuse or circuit breaker to see if it is open. Make sure fuse is not burnt, or circuit breaker is "ON" and not activated.
- Check the 12 Vdc fuse or circuit breaker to see if it is open. Make sure fuse is not burnt, or circuit breaker is "ON" and not activated.
- After the above checks, call your local service center for further help. This unit must be serviced by qualified service personnel only.

When calling for service, always give the following:

- Unit Model Number and Serial Number found on Identification Label located on the Base Pan of unit bottom. It is necessary to remove the return air cover to expose the rating plate.
- Electronic Control Kit Part Number and Serial Number found on Identification Label located on the side of the Kit. This kit is mounted in the return air cavity and can be exposed by removing the return air cover.